

# MADER

## HOME

**2013**



## INDICE

**MATERIAL ELÉCTRICO / MATERIAL ELECTRICO / ELECTRICS****ILUMINAÇÃO / ILUMINACIÓN / LIGHT**

FOCOS / PROYECTOR / LIGHT

LÂMPADA / BOMBILLA / BULB

LANTERNAS / LINTERNA / LANTERN

EXTENSÕES / PROLONGADOR / EXTENSION

FICHAS / CLAVIJA / PULG

**PINTURAS E COLAS / PINTURAS Y PEGAMENTOS / PAINTS & GLUES****SPRAY**

TINTAS / PINTURAS / INK

ÓLEO / ACEITE / OIL

**ACESSÓRIOS / ACCESORIOS / ACCESSORIES**

TRINCHAS / PALETINA / PAINT BRUSH

ROLOS / RODILLOS / ROLL

KIT PINTURA / PAINT SET

**COLAS**

SILICONE / SILICONA / SILICON

COLAS / GLUE

ÓLEO / ACEITE / OIL ( WD40 // KRAFFT )

**HOME****AQUECIMENTO / CALEFACCIÓN / WARMING**

AQUECEDORES ESPLANADA / CALENTADOR TIPO HONGO / OUTDOOR HEATER

ESTUFA PELLETS / PELLET STOVE

TERMOVENTILADORES / FAN HEATER

**ACESSÓRIOS / ACCESORIOS / ACCESSORIES**

MATA MOSCAS / MATAMOSCAS / INSECT KILER

ARTIGOS PARA CASA / ARTÍCULOS PARA HOGAR / ARTICLES FOR HOME



LINHA **ILUMINAÇÃO**

**2013**

## Foco Halógeno

### Proyector Halogeno

### Halogen Light

**FIXO**  
**FIJO**  
**FIXED**



**150 W**



**500 W**



**1000 W**



Descrição: **Foco de Halógeno Fixo**

Marca: **Mader Home**

N. Ref. Especificação

**89013** 150 W

**89005** 500 W

**24056** 1000 W

**24057** 1500 W

Quant. Caixa:

I.V.A:

**23%**

Ecorree: Ecopilhas:

**0.05€ 0.00€**

**0.08€ 0.00€**

**0.17€ 0.00€**

**0.27€ 0.00€**

**NOVAS NORMAS ENERGÉTICAS**  
**NUEVOS ESTÁNDARES DE ENERGÍA**  
**NEW ENERGY STANDARDS**

**1500 W**



## Foco Halógeno com Sensor

### Proyector Halogeno con Sensor

### Halogen Light with Sensor

**COM SENSOR**  
**CON SENSOR**  
**WITH SENSOR**



**150 W**



**500 W**



Descrição: **Foco de Halógeno**

Marca: **Mader Home**

N. Ref. Especificação

**89011** 150 W c/Sensor

**89008** 500 W c/Sensor

Quant. Caixa:

I.V.A:

**23%**

Ecorree: Ecopilhas:

**0.06€ 0.00€**

**0.10€ 0.00€**

**NOVAS NORMAS ENERGÉTICAS**  
**NUEVOS ESTÁNDARES DE ENERGÍA**  
**NEW ENERGY STANDARDS**

## Foco Halogéneo Portátil

### Proyector Halogeno Portátil

### Portable Halogen Light



150 W



500 W



Descrição: Foco de Halogéneo

Marca: Mader Home

N. Ref. Especificação

89007 150 W - Portátil

Quant. Caixa:

89010 500 W - Portátil

I.V.A:

23%

Ecorree: Ecopilhas:

0.11€ 0.00€

0.12€ 0.00€

**NOVAS NORMAS ENERGÉTICAS**  
**NUEVOS ESTÁNDARES DE ENERGÍA**  
**NEW ENERGY STANDARDS**

## Foco de Halogéneo » Portátil

### Proyector de Halogeno » Portátil

### Halogen Light » Portable

**1.5mm<sup>2</sup> 500W**

**2 TOMADAS**  
**2 TOMAS**  
**2 SOCKETS**



500 W



Descrição: Foco de Halogéneo

Marca: Mader Home

N. Ref. Especificação

68060 Portátil - 500 W - 2 Tomadas

Quant. Caixa:

I.V.A:

23%

Ecorree: Ecopilhas:

0.27€ 0.00€

## Foco Halógeno com Tripé

### Proyector Halogeno con Tripode

### Halogen Light with Tripod

Foco de Halogênio Simples  
500 W (com cabo)  
c/ Tripé Extensível até 1,83 m

Foco de Halogênio Duplo  
500 W (com cabo)  
c/ Tripé Extensível até 1,83 m



500 W



2 x 500 W



Descrição: Foco de Halógeno com Tripé

Marca: Mader Home

N. Ref. Especificação

89024 Simples - 500 W

89025 Duplo - 2 x 500 W

Quant. Caixa:

I.V.A:

23%

Ecorree: Ecopilhas:

0.09€ 0.00€

0.49€ 0.00€

**NOVAS NORMAS ENERGÉTICAS**  
**NUEVOS ESTÁNDARES DE ENERGÍA**  
**NEW ENERGY STANDARDS**

## Foco Halógeno com Tripé

### Proyector Halogeno con Tripode

### Halogen Light with Tripod

Resistente, com diversas utilizações  
em qualquer lado

Interruptor com 3 funções

Ambas as luzes inclinam a 90° e giram a 270°

Estrutura das lâmpadas em alumínio

Lentes em vidro temperado  
com grelhas metálicas

Pegas metálicas acolchoadas

Base portátil para trabalhos pesados

Tripé tubular em aço para trabalhos pesados,  
ajustável até 180cm

3 m de extensão com fichas ligadas à corrente

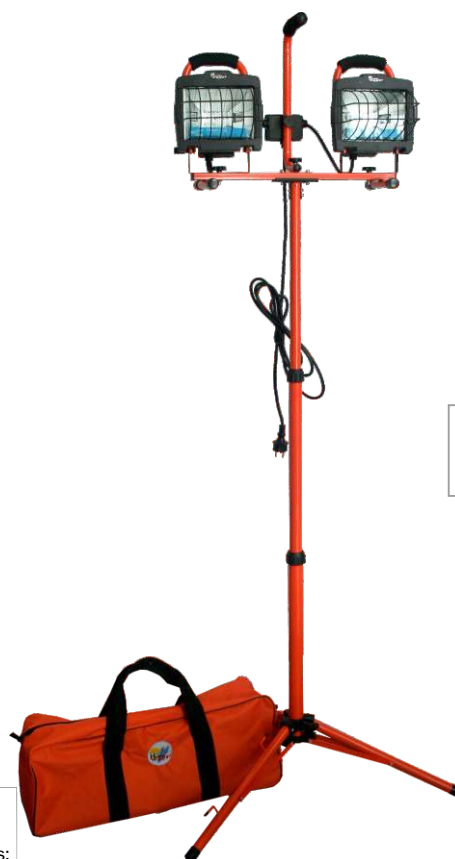

Descrição: Foco de Halógeno

Marca: Mader Home

N. Ref. Especificação

89115 2 x 500 W

Quant. Caixa:

I.V.A:

23%

Ecorree: Ecopilhas:

0.39€ 0.00€

## Lâmpadas Halogéneo

### Bombilla de Halogéneo

### Hallogen Bulbs

**150W**

**500W**

**750W**
**150W**

516022251890166

**500W**

516022251890142

**750W**

516022251890173

 Descrição: **Lâmpadas de Halogéneo**

 Marca: **Mader Home**

N. Ref.	Especificação
89016	150 W - 2 peças
89014	500 W - 2 peças
89017	750 W - 1 peças

Quant. Caixa:

I.V.A:	23%
Ecorree:	0.00€
Ecopilhas:	0.00€

## Lâmpadas Halogéneo

### Bombilla de Halogéneo

### Hallogen Bulbs

**1000W**
**1000W**

516022251890234

**1500W**
**1500W**

516022251890265

 Descrição: **Lâmpadas de Halogéneo**

 Marca: **Mader Home**

N. Ref.	Especificação
89023	1000W - 1 un
89026	1500W - 1 un

Quant. Caixa:

I.V.A:	23%
Ecorree:	0.00€
Ecopilhas:	0.00€

## Foco Fluorescente

### Proyector Fluorescent

### Fluorescent Light

2x26 W



28 W



2x26 W



28 W



Descrição: **Foco Fluorescente**

Marca: **Mader Home**

N. Ref. Especificação

89111 2 x 26 W - KM1319

89110 28 W - KM1013

Quant. Caixa:

I.V.A:

23%

Ecorree: Ecopilhas:

0.10€ 0.00€

0.12€ 0.00€

## Foco Fluorescente

### Proyector Fluorescent

### Fluorescent Light

2x18 W



2x27 W



2x18 W



2x27 W



Descrição: **Foco Fluorescente**

Marca: **Mader Home**

N. Ref. Especificação

89112 2x18W - c/Suporte - KM1317

89113 2x27W - c/Suporte - KM1318

Quant. Caixa:

I.V.A:

23%

Ecorree: Ecopilhas:

0.18€ 0.00€

0.19€ 0.00€

## Lanterna Fluorescente Projector Fluorescente Fluorescent Projector

3008



2 x 8 W



Descrição: **Lanterna Fluorescente**

Marca: **Mader Home**

N. Ref. Especificação

89151 2 x 8 W - Km3008

Quant. Caixa:

I.V.A:

23%

Ecorree: Ecopilhas:

0.12€ 0.00€

## Lanterna Fluorescente Projector Fluorescente Fluorescent Projector

3011



3012



1 x 18W



2 x 18W



Descrição: **Lanterna Fluorescente**

Marca: **Mader Home**

N. Ref. Especificação

89153 1 x 18W - KM3011

89152 2 x 18W - KM3012

Quant. Caixa:

I.V.A:

23%

Ecorree: Ecopilhas:

0.15€ 0.00€

0.17€ 0.00€

**Lanterna Fluorescente**  
**Linterna Fluorescente**  
**Fluorescent Lantern**

**C/SUPORTE**  
**C/SOPORTE**  
**W/SUPPORT**



**2 x 18 W**



**2 x 18 W**



Descrição: **Lanterna Fluorescente**

Marca: **Mader Home**

N. Ref. Especificação  
**89160 2 x 18 W - 230V**

Quant. Caixa:

I.V.A:

**23%**

Ecorree: Ecopilhas:

**0.35€ 0.00€**

**Lanterna Fluorescente**  
**Linterna Fluorescente**  
**Fluorescent Lantern**

**C/SUPORTE**  
**C/SOPORTE**  
**W/SUPPORT**



**2 x 36 W**



**2 x 36 W**



Descrição: **Lanterna Fluorescente**

Marca: **Mader Home**

N. Ref. Especificação  
**89161 2 x 36 W - c/Tripé - 230V**

Quant. Caixa:

I.V.A:

**23%**

Ecorree: Ecopilhas:

**0.35€ 0.00€**

## Lâmpada Fluorescente Bombilla Fluorescent Fluorescent Bulb

**18 W**

**27 W**

**26 W**

**38 W**

 Descrição: **Lâmpada Fluorescente**

 Marca: **Mader Home**

N. Ref. Especificação

**89266 18 W - p/ KM1317**
**89267 27 W - p/ KM1318**
**89265 26 W - p/ KM1319**
**89264 38 W - p/ KM1013**

Quant. Caixa:

I.V.A:

**23%**

Ecorree: Ecopilhas:

**0.00€ 0.00€**

## Lâmpada Fluorescente Bombilla Fluorescent Fluorescent Bulb

**8 W**

**18 W**

**36 W**

 Descrição: **Lâmpada Fluorescente**

 Marca: **Mader Home**

N. Ref. Especificação

**89261 8 W - p/ KM3008**
**89262 18 W - p/ KM1304**
**89263 36 W - p/ KM1315**

Quant. Caixa:

I.V.A:

**23%**

Ecorree: Ecopilhas:

**0.00€ 0.00€**

## Foco com Lâmpada Económica

### Proyector con Lámpara Económica

### Weather Proof Engineering Lamp

**0201**

**0202 c/sensor**

**0203 c/suporte**

 Descrição: **Foco c/ Lâmpada Económica**

 Marca: **Mader Home**

N. Ref. Especificação

Quant. Caixa:

**89124** 36W - Es0201 - Fixo

**89125** 36W - Es0202 - c/Sensor

**89126** 36W - Es0203 - c/Suporte

I.V.A:

**23%**

Ecorree: Ecopilhas:

**0.07€ 0.00€**
**0.07€ 0.00€**
**0.07€ 0.00€**

## Foco com Lâmpada Económica

### Proyector con Lámpara Económica

### Weather Proof Engineering Lamp

**32 W**
**32 W - 1663**
**36 W - 1681**
**32 W**

**32 W - 1663**

**36 W - 1681**

 Descrição: **Foco Lâmpada Económica**

 Marca: **Mader Home**

N. Ref. Especificação

Quant. Caixa:

**89120** 32W

**89121** 32W - 1663 -c/Suporte

**89122** 36W - 1681 -c/Suporte

I.V.A:

**23%**

Ecorree: Ecopilhas:

**0.07€ 0.00€**
**0.07€ 0.00€**
**0.07€ 0.00€**

## Foco com Lâmpada Económica Projector con Lámpara Económica Weather Proof Engeneering Lamp

**C/ TRIPÉ**  
**C/ TRÍPODE**  
**W/ TRIPOD**



1865



Descrição: **Foco c/ Lâmpada Económica**

Marca: **Mader Home**

N. Ref. Especificação

89123 1865 - 36W c/Tripé

Quant. Caixa:

I.V.A:

23%

Ecorree: Ecopilhas:

0.07€ 0.00€

## Lâmpada Económica Espiral Bombilla Económica Espiral Spiral Eco Bulb



**E27**

**32W**



**E27**

**36W**



**T5**

**36W**



**GU10**

**32W**

E27-32W



E27-36W



T5



GU10



Descrição: **Lâmpada Económica Espiral**

Marca: **Mader House**

N. Ref. Especificação

89254 32W - E27

89255 36W - E27

89256 36W - T5

89268 32W - GU10 - KM1331

Quant. Caixa:

I.V.A:

23%

Ecorree: Ecopilhas:

0.00€ 0.00€

## Lâmpada Económica 3U

### Bombilla Económica 3U

### 3U Eco Bulb

Vida / Lifetime

**8000 H**

Cor / Color

**6400 K**



**E14**

**7 W**



**E27**

**9 W**



**E27**

**15 W**



Descrição: **Lâmpada Económica**

Marca: **Mader Home**

N. Ref. Especificação

**89269 3 U - 7 W - E14**

**89270 3 U - 9 W - E27**

**89271 3 U - 15 W - E27**

Quant. Caixa:

I.V.A:

**23%**

Ecorree: Ecopilhas:

**0.07€ 0.00€**

## Lâmpada Económica Espiral

### Bombilla Económica Espiral

### Spiral Eco Bulb

Vida / Lifetime

**8000 H**

Cor / Color

**6400 K**



**E14**

**7 W**



**E27**

**9 W**



**E27**

**15 W**



Descrição: **Lâmpada Económica**

Marca: **Mader Home**

N. Ref. Especificação

**89272 Espiral - 7 W - E14**

**89273 Espiral - 9 W - E27**

**89274 Espiral - 15 W - E27**

Quant. Caixa:

I.V.A:

**23%**

Ecorree: Ecopilhas:

**0.07€ 0.00€**

**Foco Led**  
**Proyector Led**  
**Led Light**



1531

1531



1551

1551



Descrição: **Foco Led**

Marca: **Mader Home**

N. Ref. Especificação

89117 TLX1531 - 3W c/ Suporte

89116 TLX1551 - 3W c/Tripé

Quant. Caixa:

I.V.A:

**23%**

Ecorree: Ecopilhas:

0.16€ 0.00€

0.33€ 0.00€



**Lanterna**  
**Linterna**  
**Flashlight**

**4 AA**

**20 LED**

**20 LED'S**  
**20 LED'S**  
**20 LED'S**



**20 LED**



**8 LED'S**

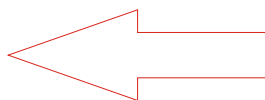

**12 LED'S**

Descrição: **Lanterna**

Marca: **Mader Home**

N. Ref. Especificação

**68050 20 LED - Expositor 12un.**

Quant. Caixa:

I.V.A:

**23%**

Ecorree: Ecopilhas:

**0.00€ 0.23€**



**Lanterna**  
**Linterna**  
**Flashlight**

**2 X AA / 3 LED**



Expositor - 12un



Descrição: **Lanterna**

Marca: **Mader Home**

N. Ref. Especificação Quant. Caixa:  
**68054 3Led - Cabeça Rotativa - Exp. 12un.**

I.V.A:

**23%**

Ecorree: Ecopilhas:

**0.00€ 0.00€**

**Lanterna Recarregável**  
**Linterna Recargable**  
**Rechargeable Work Light**

**30 + 6 LED**

**c/ Acumulador**



Descrição: **Lanterna Recarregável**

Marca: **Mader Home**

N. Ref. Especificação Quant. Caixa:  
**68057 36Led - Extensível**

I.V.A:

**23%**

Ecorree: Ecopilhas:

**0.06€ 0.00€**

**Lanterna Recarregável**  
**Linterna Recargable**  
**Rechargeable Lantern**



24 Leds



Descrição: **Lanterna de Led**

Marca: **Mader Home**

N. Ref. Especificação

**89175 24 Leds - 360° Recarregável**

Quant. Caixa:

I.V.A:

**23%**

Ecorree:

**0.02€**

Ecopilhas:

**0.00€**

**Lanterna Recarregável**  
**Linterna Recargable**  
**Rechargeable Lantern**



30 Leds



Descrição: **Lanterna de Led**

Marca: **Mader Home**

N. Ref. Especificação

**89149 30 Leds - Recarregável**

Quant. Caixa:

I.V.A:

**23%**

Ecorree:

**0.03€**

Ecopilhas:

**0.00€**

**Lanterna Recarregável**  
**Linterna Recargable**  
**Rechargeable Lantern**

**BATERIA LÍTIO**



30 Leds



Descrição: **Lanterna Recarregável**

Marca: **Mader Home**

N. Ref. Especificação

**89176 30 Leds - Recarregável**

Quant. Caixa:

I.V.A:

**23%**

Ecorree:

**0.03€**

Ecopilhas:

**0.00€**

**Lanterna Solar**  
**Linterna Solar**  
**Solar Torch**

**3 LED**



Descrição: <b>Lanterna Solar</b>	I.V.A:	
Marca: <b>Mader Home</b>	<b>23%</b>	
N. Ref. Especificação	Ecorree:	Ecopilhas:
<b>68056</b> <b>3 Led</b>	<b>0.00€</b>	<b>0.00€</b>

**Lanterna de Cabeça**  
**Linterna de Cabeça**  
**Head Lantern**

**17 LED**



**17 Led**



Descrição: <b>Lanterna p/Cabeça</b>	I.V.A:	
Marca: <b>Mader Home</b>	<b>23%</b>	
N. Ref. Especificação	Ecorree:	Ecopilhas:
<b>89171</b> <b>17 Led</b>	<b>0.02€</b>	<b>0.00€</b>

**Lanterna p/Cabeça**  
**Linterna p/Cabeça**  
**Head Light**

**3+1 LED**

**GRANDE ALCANCE**



**3+1 Led**



Descrição: <b>Lanterna p/Cabeça</b>	I.V.A:	
Marca: <b>Mader Home</b>	<b>23%</b>	
N. Ref. Especificação	Ecorree:	Ecopilhas:
<b>89170</b> <b>3 + 1 Led</b>	<b>0.01€</b>	<b>0.00€</b>

**Lanterna para Bicicleta**  
**Linterna de Bicicleta**  
**Bikelight**



Descrição: **Lanterna Recarregável**  
 Marca: **Mader Home**  
 N. Ref. Especificação Quant. Caixa:  
**54299 de Mão e p/Bicicleta - EU-T9195**

I.V.A:  
**23%**  
 Ecorree: Ecopilhas:  
**0.01€ 0.00€**

**Lanterna**  
**Linterna**  
**Flashlight**

*C/ DÍNAMO*



**Dinamo**



Descrição: **Lanterna Recarregável**  
 Marca: **Mader Home**  
 N. Ref. Especificação Quant. Caixa:  
**54294 L280 - Mão - 3 LED (dinamo)**

I.V.A:  
**23%**  
 Ecorree: Ecopilhas:  
**0.00€ 0.00€**

**Lanterna Recarregável**  
**Linterna Recargable**  
**Rechargeable Lantern**

*C/ DÍNAMO*



**6 Leds**



Descrição: **Lanterna Recarregável**  
 Marca: **Mader Home**  
 N. Ref. Especificação Quant. Caixa:  
**89177 6 Leds - Dinamo**

I.V.A:  
**23%**  
 Ecorree: Ecopilhas:  
**0.05€ 0.00€**

**Lanterna/Carregador Telemóvel » Expositor**  
**Linterna/Cargador Móvil » Expositor**  
**Flashlight to Phone » Display**

**Sun. 3 Led's**



**Expositor - 8 un**



Descrição: **Lanterna/Carregador Telemóvel**  
 Marca: **Mader House**  
 N. Ref. Especificação  
**89172 3 Led's + 4 adaptadores - 8un.**

Quant. Caixa:

I.V.A: **23%**  
 Ecorree: **0.18€** Ecopilhas: **0.00€**

**C/ DÍNAMO**

- » **Nokia**
- » **Samsung**
- » **Sony Ericsson**
- » **Motorola**

**Lanterna Alumínio » Expositor**  
**Linterna Alumínio » Expositor**  
**Aluminum Flashlight » Display**

**15un. 6 Led's**

**Cabo em Borracha**  
**Mango de Goma**  
**Rubber Handle**



**Expositor - 15 un**



Descrição: **Lanterna Alumínio**  
 Marca: **Mader House**  
 N. Ref. Especificação  
**89162 6 Led's + 1 Laser - 3AAA - 15un.**

Quant. Caixa:

I.V.A: **23%**  
 Ecorree: **0.27€** Ecopilhas: **0.00€**

**LASER**

**Lanterna**  
 Linterna  
 Flashlight

**3X AAA / 9 LED**

Expositor - 16un

**ALUMÍNIO**  
**ALUMINIO**  
**ALUMINUM**

Descrição: <b>Lanterna</b>	I.V.A:	
Marca: <b>Mader Home</b>	<b>23%</b>	
N. Ref. Especificação	Ecorree:	Ecopilhas:
<b>68051 9 Led - Expositor 16 un.</b>	<b>0.08€</b>	<b>0.00€</b>

**Lanterna**  
 Linterna  
 Flashlight

**3 X AAA / 9 LED**

Expositor - 24 un



Descrição: <b>Lanterna</b>	I.V.A:	
Marca: <b>Mader Home</b>	<b>23%</b>	
N. Ref. Especificação	Ecorree:	Ecopilhas:
<b>68053 9 Led - Expositor 24 un.</b>	<b>0.08€</b>	<b>0.00€</b>

**Lanterna**  
 Linterna  
 Flashlight

**1X AA / 0.5W**

Expositor - 16un



Descrição: <b>Lanterna</b>	I.V.A:	
Marca: <b>Mader Home</b>	<b>23%</b>	
N. Ref. Especificação	Ecorree:	Ecopilhas:
<b>68052 0.5W - Expositor 16un.</b>	<b>0.00€</b>	<b>0.10€</b>

**Lanterna**  
**Linterna**  
**FlashLight**

**BORRACHA**  
**GOMA**  
**RUBBER**



2158



2159



2160



Descrição: **Lanterna Cabo Borracha**

Marca: **Mader Home**

N. Ref. Especificação

89165 Borracha D/BL - Km2158

89166 Borracha D/BL - Km2159

89167 Borracha D/BL - KM2160

Quant. Caixa:

I.V.A:

23%

Ecorree: Ecopilhas:

0.01€ 0.00€

0.03€ 0.00€

0.03€ 0.00€

**Lanterna de Emergência**  
**Linterna de Emergência**  
**Emergency Lantern**

**9 LED**

**MAGNÉTICA**  
**MAGNÉTICA**  
**MAGNETIC**

**CORTA CINTO SEGURANÇA**  
**CORTE CINTURÓN DE SEGURIDAD**  
**CUT SAFETY BELT**



**MARTELO**  
**MARTILLO**  
**HAMMER**



Descrição: **Lanterna Emergência**

Marca: **Mader Home**

N. Ref. Especificação

54296 Multifunções- 9 Led - Magnética

Quant. Caixa:

I.V.A:

23%

Ecorree: Ecopilhas:

0.02€ 0.00€

0.02€ 0.00€

## Lanterna Linterna Flashlight



94W824



Descrição: **Lanterna de Mão**  
 Marca: **Mader Home**  
 N. Ref. Especificação  
**54295 Recarregável - 94W824**

Quant. Caixa:

I.V.A: **23%**  
 Ecorree: **0.02€** Ecopilhas: **0.00€**

## Mini Lanterna Minilinterna Mini Torch Set

3un.

**P/ PORTA CHAVES**  
**P/ COLGADOR DE LLAVES**  
**W/ KEY RINGS**



3 UN.



Descrição: **Mini-Lanterna**  
 Marca: **Mader Home**  
 N. Ref. Especificação  
**33264 p/Porta Chaves - 3 Peças**  
**89018 p/Porta Chaves - 3 Peças**

Quant. Caixa:

I.V.A: **23%**  
 Ecorree: **0.01€** Ecopilhas: **0.00€**

3 UN.



## Lanterna de Led Extensível Linterna de Led Extensible Led Pick Up Tool

**MAGNÉTICA**  
**MAGNÉTICA**  
**MAGNETIC**



Descrição: **Lanterna de Led Extensível**  
 Marca: **Mader House**  
 N. Ref. Especificação  
**89178 Magnética**

Quant. Caixa:

I.V.A: **23%**  
 Ecorree: **0.00€** Ecopilhas: **0.00€**

## Gambiarra Portátil Eléctrico Working Light

5M

60W

PLÁSTICA  
PLASTICO  
PLASTIC



Descrição: **Gambiarra**  
 Marca: **Mader House**  
 N. Ref. Especificação  
**89145 60W - 5m - Plástica**

Quant. Caixa:

I.V.A: **23%**  
 Ecorree: **0.03€** Ecopilhas: **0.00€**

## Gambiarra Portátil Eléctrico Work Light

5M

60W

COM ÍMAN  
CON IMÁN  
WITH MAGNET

INTERRUPTOR À PROVA DE ÁGUA  
CONMUTADOR A PRUEBA DEL AGUA  
WATER PROOF SWITCH



60W



Descrição: **Gambiarra Fluorescente**  
 Marca: **Mader Home**  
 N. Ref. Especificação  
**89146 KM0501003 - 60W - 5m**

Quant. Caixa:

I.V.A: **23%**  
 Ecorree: **0.06€** Ecopilhas: **0.00€**

## Gambiarra Portátil Eléctrico Work Light

5M

60W



60 W



Descrição: **Gambiarra Fluorescente**  
 Marca: **Mader Home**  
 N. Ref. Especificação  
**89159 KM0501031 - 60W - 5m**

Quant. Caixa:

I.V.A: **23%**  
 Ecorree: **0.06€** Ecopilhas: **0.00€**

## Gambiarra Portátil Eléctrico Working Light

**METÁLICA**  
**METALICA**  
**METAL**

**5M**
**60W**

**60 W**

Descrição: **Gambiarra**  
 Marca: **Mader Home**  
 N. Ref. Especificação  
**89143 Metal - 60W - 5m**

Quant. Caixa:

I.V.A: **23%**  
 Ecorree: **0.06€** Ecopilhas: **0.00€**

## Gambiarra Portátil Eléctrico Working Light

**METÁLICA**  
**METALICA**  
**METAL**

**5M**
**60W**

Descrição: **Gambiarra**  
 Marca: **Mader House**  
 N. Ref. Especificação  
**89144 60W - 5m**

Quant. Caixa:

I.V.A: **23%**  
 Ecorree: **0.00€** Ecopilhas: **0.00€**

## Gambiarra Portátil Eléctrico Work Light

**24LED**

**24 Led**

 Descrição: **Gambiarra Recarregável**

 Marca: **Mader Home**

 N. Ref. Especificação  
**89148 24 Led**

Quant. Caixa:

I.V.A:

**23%**

Ecorree: Ecopilhas:

**0.05€**
**0.00€**
**RECARREGÁVEL  
RECARGABLE  
RECHARGEABLE**

## Gambiarra Portátil Eléctrico Work Light

**60LED**

 . Bateria / Batería / Battery:  
 7.2V - 800MAH, Ni-MH

 . Tempo de Trabalho / Tiempo de Trabajo / Work Time:  
 3H

 . Tempo de Carga / Tiempo de Carga / Charger Time:  
 5-6H

. Carregador AC-DC e de 12V /
 Cargador AC-DC y de 12V /

AC-DC Charger and 12V Charger

 . Função Magnética / Función Magnética / Magnetic  
 Function

**60LED**

 Descrição: **Gambiarra Fluorescente**

 Marca: **Mader Home**

N. Ref. Especificação

**89156 KM0501018 - 60LED**

Quant. Caixa:

I.V.A:

**23%**

Ecorree: Ecopilhas:

**0.07€**
**0.00€**
**RECARREGÁVEL  
RECARGABLE  
RECHARGEABLE**

## Gambiarra Portátil Eléctrico Work Light

**100LED**

 . Bateria / Batería / Battery:  
 7.2V - 1200MAH, Ni-MH

 . Tempo de Trabalho / Tiempo de Trabajo / Work Time:  
 3H

 . Tempo de Carga / Tiempo de Carga / Charger Time:  
 5-6H

. Carregador AC-DC e de 12V /
 Cargador AC-DC y de 12V /

AC-DC Charger and 12V Charger

 . Função Magnética / Función Magnética / Magnetic  
 Function

**100LED**

 Descrição: **Gambiarra Fluorescente**

 Marca: **Mader Home**

N. Ref. Especificação

**89155 KM0501149 - 100LED**

Quant. Caixa:

I.V.A:

**23%**

Ecorree: Ecopilhas:

**0.08€**
**0.00€**
**RECARREGÁVEL  
RECARGABLE  
RECHARGEABLE**

## Gambiarra Portátil Eléctrico Work Light

**5M**
**8W**

**LUZ FLUORESCENTE**  
**LUZ FLUORESCENTE**  
**FLUORESCENT LIGHT**

**8 W**

Descrição: **Gambiarra Fluorescente**  
 Marca: **Mader Home**  
 N. Ref. Especificação  
**27060 KM0501027 - 8W - 5M**

Quant. Caixa:

I.V.A:  
**23%**  
 Ecorree: Ecopilhas:  
**0.04€ 0.00€**

## Gambiarra Portátil Eléctrico Work Light

**5M**
**11W**

**LUZ FLUORESCENTE**  
**LUZ FLUORESCENTE**  
**FLUORESCENT LIGHT**

INTERRUPTOR À PROVA DE ÁGUA  
 CONMUTADOR A PRUEBA DEL AGUA  
 WATER PROOF SWITCH

**11 W**

Descrição: **Gambiarra Fluorescente**  
 Marca: **Mader Home**  
 N. Ref. Especificação  
**89158 KM0501369 - 11W - 5M**

Quant. Caixa:

I.V.A:  
**23%**  
 Ecorree: Ecopilhas:  
**0.08€ 0.00€**

## Gambiarra Portátil Eléctrico Work Light

**5M**
**30W**

**30W**

Descrição: **Gambiarra Fluorescente**  
 Marca: **Mader Home**  
 N. Ref. Especificação  
**89157 KM0501358 - 30W - 5M**

Quant. Caixa:

I.V.A:  
**23%**  
 Ecorree: Ecopilhas:  
**0.20€ 0.00€**

**LUZ FLUORESCENTE**  
**LUZ FLUORESCENTE**  
**FLUORESCENT LIGHT**

## Olho Boi Aplique Ovalado Bulk Head Light

**E27**
**BRANCO**
**METÁLICO  
METÁLICO  
METALIC**

**60 W**

**60 W c/protec.**

**100 W c/protec.**
**60 W**

**60 W c/protec.**

**100 W c/protec.**

 Descrição: **Olho Boi**

 Marca: **Mader Home**

N. Ref. Especificação

**89082 60W - Branco**
**89081 60W c/Protecção - Branco**
**89080 100 W c/Protecção - Branco**

Quant. Caixa:

I.V.A:

**23%**

Ecorree: Ecopilhas:

**0.00€ 0.00€**
**COM PROTECÇÃO  
CON PROTECCIÓN  
WITH GUARD**

## Olho Boi Aplique Ovalado Bulk Head Light

**E27**
**PRETO**
**METÁLICO  
METÁLICO  
METALIC**

**60 W**

**60 W c/protec.**
**60 W - Preto**

**60 W c/protec. - Preto**

 Descrição: **Olho Boi**

 Marca: **Mader Home**

N. Ref. Especificação

**89086 60W - Preto**
**89084 60W c/Protecção - Preto**

Quant. Caixa:

I.V.A:

**23%**

Ecorree: Ecopilhas:

**0.00€ 0.00€**
**COM PROTECÇÃO  
CON PROTECCIÓN  
WITH GUARD**

## Olho Boi Aplique Ovalado Bulk Head Light

**E27**
**Verde**
**METÁLICO  
METÁLICO  
METALIC**

**60 W**

**60 W c/protec.**
**60 W - Verde**

**60 W c/protec. - Verde**

 Descrição: **Olho Boi**

 Marca: **Mader Home**

N. Ref. Especificação

**89087 60W - Verde**
**89085 60W c/Protecção - Verde**

Quant. Caixa:

I.V.A:

**23%**

Ecorree: Ecopilhas:

**0.00€ 0.00€**
**COM PROTECÇÃO  
CON PROTECCIÓN  
WITH GUARD**

## Candeeiro Exterior

### Aplicador Exterior / Colgante

### Outside Lamp

60W

**COM SENSOR**  
**CON SENSOR**  
**WITH SENSOR**



**SEM SENSOR**  
**SIN SENSOR**  
**WITHOUT SENSOR**



Descrição: **Candeeiro Exterior**

Marca: **Mader House**

N. Ref. Especificação  
89095 60W - t/ Aplicador - c/ Sensor  
89096 60W - t/ Aplicador

Quant. Caixa:

I.V.A: 23%  
Ecorree: 0.12€  
Ecopilhas: 0.00€

## Candeeiro Exterior

### Aplicador Exterior / Colgante

### Outside Lamp

60W



Descrição: **Candeeiro Exterior**

Marca: **Mader House**

N. Ref. Especificação  
89093 60W - t/Pilar  
89094 60W - t/Lanterna

Quant. Caixa:

I.V.A: 23%  
Ecorree: 0.12€  
Ecopilhas: 0.00€

## Enrolador Enrollacable Reel



25 m



50 m



Descrição: Enrolador

Marca: Mader Home

N. Ref. Especificação

68015 Capacidade para 25m

68016 Capacidade para 50m

Quant. Caixa:

I.V.A:

23%

Ecorree: Ecopilhas:

0.00€

0.00€

FIO ELÉCTRICO NÃO INCLUÍDO »  
 CORDÓN ELÉCTRICO NO PROVEÍDO »  
 NON INCLUDED CORD

## Extensão Eléctrica Prolongador Eléctrico Electric Extension

**3Gx1.0MM<sup>2</sup> 5M**

**COM ENROLADOR  
 CON ENROLLACABLE  
 WITH CABLE REEL**

**3Gx1.0MM<sup>2</sup> 10M**

**COM ENROLADOR  
 CON ENROLLACABLE  
 WITH CABLE REEL**



Descrição: Extensão Eléctrica

Marca: Mader House

N. Ref. Especificação

89315 4 saídas - c/ Enrolador - 5m

56042 4 saídas - c/ Enrolador - 10m

Quant. Caixa:

I.V.A:

23%

Ecorree: Ecopilhas:

0.00€

0.00€

## Extensão Eléctrica Prolongador Eléctrico Electrical Cable Extension

**COM ENROLADOR PLÁSTICO  
CON ENROLLACABLE PLASTICO  
WITH PLASTIC REEL**

**3Gx1.5MM<sup>2</sup>**

**25M**

VDE

- 25 m
- Saídas / Tomas / Safety Socket Outlets
- 4

Cabo / Cable / Cable

- 3G x 1.5 mm<sup>2</sup>



25 m



546022254680217

**3Gx1.5MM<sup>2</sup>**

**50M**

VDE

- 50 m
- Saídas / Tomas / Safety Socket Outlets
- 4

Cabo / Cable / Cable

- 3G x 1.5 mm<sup>2</sup>



50 m



546022254680224

Descrição: Extensão Eléctrica

Marca: Mader Home

N. Ref. Especificação

Quant. Caixa:

68021 c/ Enrolador - 25m - 1.5mm<sup>2</sup>

68022 c/ Enrolador - 50m - 1.5mm<sup>2</sup>

I.V.A:

23%

Ecorree: Ecopilhas:

0.00€ 0.00€



## Extensão Eléctrica

### Prolongador Eléctrico

### Electrical Cable Extension

**COM ENROLADOR METÁLICO**  
**CON ENROLLACABLE METÁLICO**  
**WITH METALIC REEL**

**3Gx2.5MM<sup>2</sup>**

**15M**

VDE

- 15 m
- Saídas / Tomas / Safety Socket Outlets
- 4

Cabo / Cable / Cable

- 3 x 2.5 mm<sup>2</sup>



15 m



516022251680200

**3Gx2.5MM<sup>2</sup>**

**30M**

VDE

- 30 m
- Saídas / Tomas / Safety Socket Outlets
- 4

Cabo / Cable / Cable

- 3 x 2.5 mm<sup>2</sup>



30 m



516022251560540

**3Gx2.5MM<sup>2</sup>**

**50M**

VDE

- 50 m
- Saídas / Tomas / Safety Socket Outlets
- 4

Cabo / Cable / Cable

- 3 x 2.5 mm<sup>2</sup>



50 m



516022251560557

Descrição: Extensão Eléctrica

Marca: Mader Home

N. Ref. Especificação Quant. Caixa:

68020 c/ Enrol. Metál. - 15m - 2.5mm<sup>2</sup>

56054 c/ Enrol. Metál. - 30m - 2.5mm<sup>2</sup>

56055 c/ Enrol. Metál. - 50m - 2.5mm<sup>2</sup>

I.V.A:

23%

Ecorree: Ecopilhas:

0.00€ 0.00€



## Extensão Eléctrica c/ Enrolador Prolongador Eléctrico c/ Enrollacable Cable Reels

50 m

1.5mm<sup>2</sup>

MGL - 50 m

Enrolador / Enrollacable / Reel

- Plástico c/ Pega Ergonómica
- Plastico c/ Asa Ergonómica
- Plastic w/ Carrying Handle

• Saídas / Tomas / Safety Socket Outlets

- 4

VDE

- 50 m

Cabo / Cable / Cable

- 3 x 1.5 mm<sup>2</sup>

Terra / Tierra / Earth

- Sim / Sin / Yes

• Térmico / Térmico / Thermal

- Sim / Sin / Yes



1.5 mm<sup>2</sup>



Descrição: Extensão Eléctrica

Marca: Mader Gold

N. Ref. Especificação

89322 c/ Enrolador - 50m - 1.5mm<sup>2</sup>

Quant. Caixa:

I.V.A:

23%

Ecorree: Ecopilhas:

0.00€ 0.00€



## Extensão Eléctrica Prolongador Eléctrico Extension Socket

**3Gx1.0MM<sup>2</sup>**
**3 Saídas**

**COM INTERRUPTOR  
CON CONMUTADOR  
WITH SWITCH**

- Saídas / Tomas / Safety Socket Outlets
- 3
- Cabo / Cable / Cable
- 3G x 1.0 mm<sup>2</sup>
- Terra / Tierra / Earth
- Sim / Sin / Yes

**1.5 m**

**3 m**

**5 m**

Descrição: Extensão Eléctrica c/ Interruptor

Marca: Mader Home

N. Ref. Especificação

Quant. Caixa:

 89304 3 saídas - 1mm<sup>2</sup> - 1.5 m

 89305 3 saídas - 1mm<sup>2</sup> - 3.0 m

 89309 3 saídas - 1mm<sup>2</sup> - 5.0 m

I.V.A:

**23%**

Ecorree: Ecopilhas:

**0.00€ 0.00€**

## Extensão Eléctrica Prolongador Eléctrico Extension Socket

**3Gx2.5MM<sup>2</sup>**
**3 Saídas**

**COM INTERRUPTOR  
CON CONMUTADOR  
WITH SWITCH**

VDE

- 1.5 m # 3 m # 5 m
- Saídas / Tomas / Safety Socket Outlets
- 3
- Cabo / Cable / Cable
- 3G x 2.5 mm<sup>2</sup>
- Terra / Tierra / Earth
- Sim / Sin / Yes

**1.5 m**

**3.0 m**

**5.0 m**

Descrição: Extensão Eléctrica c/ Interruptor

Marca: Mader House

N. Ref. Especificação

Quant. Caixa:

 89306 3 saídas - 2.5mm<sup>2</sup> - 1.5 m

 89307 3 saídas - 2.5mm<sup>2</sup> - 3.0 m

 56085 3 saídas - 2.5mm<sup>2</sup> - 5.0 m

 89308 3 saídas - 2.5mm<sup>2</sup> - 5.0 m

I.V.A:

**23%**

Ecorree: Ecopilhas:

**0.00€ 0.00€**
**5.0 m**

## Extensão Eléctrica Prolongador Eléctrico Extension Socket

**3Gx1.5MM<sup>2</sup> 5 Saídas**

**COM INTERRUPTOR  
CON CONMUTADOR  
WITH SWITCH**



1.5 m x 1.0 mm<sup>2</sup>



3 m x 1.5 mm<sup>2</sup>



5 m x 1.5 mm<sup>2</sup>



VDE

- 5 m
- Saídas / Tomas / Safety Socket Outlets
- 5
- Cabo / Cable / Cable
- 3G x 1.5 mm<sup>2</sup>
- Terra / Tierra / Earth
- Sim / Sin / Yes

Descrição: Extensão Eléctrica

Marca: Mader Home

N. Ref. Especificação Quant. Caixa:

68000 5 saídas - 1.5m x 1.0mm<sup>2</sup>

68001 5 saídas - 3.0m x 1.5mm<sup>2</sup>

68002 5 saídas - 5.0m x 1.5mm<sup>2</sup>

I.V.A:

23%

Ecorree: Ecopilhas:

0.00€ 0.00€

## Extensão Eléctrica Prolongador Eléctrico Extension Socket

**3Gx1.5MM<sup>2</sup> 8 Saídas**

**COM INTERRUPTOR  
CON CONMUTADOR  
WITH SWITCH**



3m x 1.5 mm<sup>2</sup>



VDE

- 3 m
- Saídas / Tomas / Safety Socket Outlets
- 8
- Cabo / Cable / Cable
- 3G x 1.5 mm<sup>2</sup>
- Terra / Tierra / Earth
- Sim / Sin / Yes

- Com Interruptor / Con Conmutador / With Switch
- Protecção contra Descargas / Protección contra Descargas / Overload Protection
- Com Protecção para Crianças / Con Protección para Niños / Children Protection
- Ficha para Telefone e TV/ Clavija para Teléfono y TV / Telephone and TV Jack

Descrição: Extensão Eléctrica

Marca: Mader House

N. Ref. Especificação Quant. Caixa:

56064 8 saídas - 3.0m x 1.5mm<sup>2</sup>

I.V.A:

23%

Ecorree: Ecopilhas:

0.00€ 0.00€

## Caixa de Distribuição c/Disjuntor Caja de Distribución c/Disyuntor Distribution Box with Breaker

Entrada / Entrada / Input :

- . 1 ficha eléctrica 16A 5P 415V CEE
- .Cabo 2m 5G 23.5sq mm

Saída / Salida / Output:

- . 2 tomadas 16A 3P+N+E 415V HTN CEE/
- . 2 enchufes 16A 3P+N+E 415V HTN CEE/
- . 2 sockets 16A 3P+N+E 415V HTN CEE
- . 3 tomadas 16A 3P 230V HTN CEE/
- . 3 enchufes 16A 3P 230V HTN CEE/
- . 3 sockets 16A 3P 230V HTN CEE

.Fusíveis de protecção / Fusibles / Fuses

- ..2 16A 3P 415V MCB
- .4 16A 1P 230V MCB



Descrição: Caixa de Distribuição c/Disjuntor

Marca: Mader Home

N. Ref. Especificação

Quant. Caixa:

89180 Monofásica/Trifásica- KM 1224

I.V.A:

23%

Ecorree: Ecopilhas:

0.00€ 0.00€

## Ficha Eléctrica c/ Temporizador Clavija Eléctrica c/ Temporizador Electric Plug with Timer

**24 h**

Diária

- . 10 -16 A
- . 250 W
- . MÁX. 3500 W



TG - 22A



E-59500



Descrição: Ficha Eléctrica c/Temporizador

Marca: Mader Home

N. Ref. Especificação

Quant. Caixa:

56053 TG - 22A

56052 E-59500

I.V.A:

23%

Ecorree: Ecopilhas:

0.00€ 0.00€



## Ficha Eléctrica - Fêmea

### Clavija - Hembra

### Plug



Descrição: <b>Ficha Eléctrica PVC</b>			I.V.A:		
Marca: <b>Mader Home</b>			23%		
N. Ref.	Especificação	Quant. Caixa:	Ecorree:	Ecopilhas:	
89220	Monofásica - Fêmea - 3 Pins	10	0.00€	0.00€	

**C/ TERRA**  
**TIERRA**  
**GROUND**

**3 Pins(2+1)**

## Ficha Eléctrica - Macho

### Clavija - Macho

### Plug

**C/ TERRA**  
**TIERRA**  
**GROUND**



Descrição: <b>Ficha Eléctrica</b>			I.V.A:		
Marca: <b>Mader Home</b>			23%		
N. Ref.	Especificação	Quant. Caixa:	Ecorree:	Ecopilhas:	
89219	Monofásica - Macho - 3 Pins	10	0.00€	0.00€	

**3 Pins(2+1)**

## Ficha Eléctrica - Fêmea

### Clavija - Hembra

### Plug



Descrição: <b>Ficha Eléctrica PVC</b>			I.V.A:		
Marca: <b>Mader Home</b>			23%		
N. Ref.	Especificação	Quant. Caixa:	Ecorree:	Ecopilhas:	
89222	Trifásica - Fêmea - 4 Pins	10	0.00€	0.00€	

**C/ TERRA**  
**TIERRA**  
**GROUND**

**4 Pins(3+1)**

## Ficha Eléctrica - Macho

### Clavija - Macho

### Plug

**C/ TERRA**  
**TIERRA**  
**GROUND**



Descrição: <b>Ficha Eléctrica PVC</b>			I.V.A:		
Marca: <b>Mader Home</b>			23%		
N. Ref.	Especificação	Quant. Caixa:	Ecorree:	Ecopilhas:	
89221	Trifásica - Macho - 4 Pins	10	0.00€	0.00€	

**4 Pins(3+1)**

## Ficha Eléctrica - Fêmea

### Clavija - Hembra

### Plug

**C/ TERRA**  
**TIERRA**  
**GROUNDDED**

**PVC**



**50 UN./CX**

Descrição: **Ficha Eléctrica**

Marca: **Mader Home**

N. Ref. Especificação Quant. Caixa:  
**89204 ZXZ-08 - c/ Terra - Fêmea - PVC 50 peças**

I.V.A:

**23%**

Ecorree: Ecopilhas:

**0.00€ 0.00€**

## Ficha Eléctrica - Macho

### Clavija - Macho

### Plug

**C/ TERRA**  
**TIERRA**  
**GROUNDDED**

**PVC**



**50 UN./CX**

Descrição: **Ficha Eléctrica**

Marca: **Mader Home**

N. Ref. Especificação Quant. Caixa:  
**89203 ZXZ-07 - c/Terra - Macho - PVC 50 peças**

I.V.A:

**23%**

Ecorree: Ecopilhas:

**0.00€ 0.00€**

## Ficha Eléctrica - Fêmea

### Clavija - Hembra

### Plug

**C/ TERRA**  
**TIERRA**  
**GROUNDDED**

**BORRACHA**  
**GOMA**  
**RUBBER**



**1 UN.**

Descrição: **Ficha Eléctrica**

Marca: **Mader Home**

N. Ref. Especificação Quant. Caixa:  
**89218 c/ Terra - Fêmea - Borracha**

I.V.A:

**23%**

Ecorree: Ecopilhas:

**0.00€ 0.00€**

## Ficha Eléctrica - Macho

### Clavija - Macho

### Plug

**C/ TERRA**  
**TIERRA**  
**GROUNDDED**

**BORRACHA**  
**GOMA**  
**RUBBER**



**1 UN.**

Descrição: **Ficha Eléctrica**

Marca: **Mader Home**

N. Ref. Especificação Quant. Caixa:  
**89217 c/Terra - Macho - Borracha**

I.V.A:

**23%**

Ecorree: Ecopilhas:

**0.00€ 0.00€**

## Ficha Eléctrica - Fêmea

### Clavija - Hembra

### Plug



Descrição: <b>Ficha Eléctrica</b>			I.V.A:	
Marca: <b>Mader Home</b>			23%	
N. Ref.	Especificação	Quant. Caixa:	Ecorree:	Ecopilhas:
89205	ZXZ-09 - s/ Terra - Fêmea	50 peças	0.00€	0.00€

**50 UN./CX**

## Ficha Eléctrica - Macho

### Clavija - Macho

### Plug



Descrição: <b>Ficha Eléctrica</b>			I.V.A:	
Marca: <b>Mader Home</b>			23%	
N. Ref.	Especificação	Quant. Caixa:	Ecorree:	Ecopilhas:
89206	ZXZ-11 - s/Terra - Macho	50 peças	0.00€	0.00€

**50 UN./CX**

## Ficha Eléctrica - Tripla

### Clavija - Tripla

### Plug



Descrição: <b>Ficha Eléctrica</b>			I.V.A:	
Marca: <b>Mader Home</b>			23%	
N. Ref.	Especificação	Quant. Caixa:	Ecorree:	Ecopilhas:
89228	ZXZ-06 - s/Terra - Tripla	20 peças	0.00€	0.00€

**20 UN./CX**

## Suporte Lâmpada

### Soporte Aplique

### Bulb Frame



Descrição: <b>Suporte Lâmpada</b>			I.V.A:	
Marca: <b>Mader Home</b>			23%	
N. Ref.	Especificação	Quant. Caixa:	Ecorree:	Ecopilhas:
89209	ZXZ-10 - E27	50 peças	0.00€	0.00€

**50 UN./CX**

## Ficha Eléctrica - Fêmea

### Clavija - Hembra

### Plug

**C/ TERRA**  
**TIERRA**  
**GROUNDED**



Descrição: <b>Ficha Eléctrica</b>			I.V.A:	
Marca: <b>Mader Home</b>			23%	
N. Ref.	Especificação	Quant. Caixa:	Ecorree:	Ecopilhas:
89201	ZXZ-02 - c/ Terra - Fêmea	50 peças	0.00€	0.00€

**50 UN./CX**

## Ficha Eléctrica - Macho

### Clavija - Macho

### Plug

**C/ TERRA**  
**TIERRA**  
**GROUNDED**



Descrição: <b>Ficha Eléctrica</b>			I.V.A:	
Marca: <b>Mader Home</b>			23%	
N. Ref.	Especificação	Quant. Caixa:	Ecorree:	Ecopilhas:
89225	ZXZ-01 - c/Terra - Macho	25 peças	0.00€	0.00€

**25 UN./CX**

## Ficha Eléctrica - Macho

### Clavija - Macho

### Plug

**C/ TERRA**  
**TIERRA**  
**GROUNDED**



90°



Descrição: <b>Ficha Eléctrica</b>			I.V.A:	
Marca: <b>Mader Home</b>			23%	
N. Ref.	Especificação	Quant. Caixa:	Ecorree:	Ecopilhas:
89226	ZXZ-04 - c/Terra - Macho - 90°	20 peças	0.00€	0.00€

**20 UN./CX**

## Ficha Eléctrica - Tripla

### Clavija - Tripla

### Plug

**C/ TERRA**  
**TIERRA**  
**GROUNDED**



Descrição: <b>Ficha Eléctrica</b>			I.V.A:	
Marca: <b>Mader Home</b>			23%	
N. Ref.	Especificação	Quant. Caixa:	Ecorree:	Ecopilhas:
89227	ZXZ-15 - c/Terra - Tripla	10 peças	0.00€	0.00€

**10 UN./CX**

## Tomada Interior Enchufe Interior Socket

**C/ TERRA  
TIERRA  
GROUNDED**



**50 UN./CX**

Descrição: Tomada Interior		I.V.A: 23%	
Marca: Mader Home		Ecorree: 0.00€	Ecopilhas: 0.00€
N. Ref.	Especificação	Quant. Caixa:	
89211	ZXZ-03 c/Terra - Quadrada	50 Peças	

## Tomada Exterior Enchufe Exterior Exterior Socket

**C/ TERRA  
TIERRA  
GROUNDED**



**12 UN./CX**

Descrição: Tomada Exterior		I.V.A: 23%	
Marca: Mader Home		Ecorree: 0.00€	Ecopilhas: 0.00€
N. Ref.	Especificação	Quant. Caixa:	
89223	c/Terra - Quadrada	12 Peças	
68044	c/Terra - Quadrada - Duplo Blister		



**Duplo Blister**

## Ficha Eléctrica - Fêmea

### Clavija - Hembra

### Plug



Descrição: <b>Ficha Eléctrica</b>			I.V.A: <b>23%</b>	
Marca: <b>Mader Home</b>			Ecorree: <b>0.00€</b>	Ecopilhas: <b>0.00€</b>
N. Ref. <b>68033</b>	Especificação <b>s/ Terra - Fêmea</b>	Quant. Caixa: <b>12 peças</b>		

## Ficha Eléctrica - Macho

### Clavija - Macho

### Plug



Descrição: <b>Ficha Eléctrica</b>			I.V.A: <b>23%</b>	
Marca: <b>Mader Home</b>			Ecorree: <b>0.00€</b>	Ecopilhas: <b>0.00€</b>
N. Ref. <b>68034</b>	Especificação <b>s/Terra - Macho</b>	Quant. Caixa: <b>12 peças</b>		

## Ficha Eléctrica - Tripla

### Clavija - Tripla

### Plug



Descrição: <b>Ficha Eléctrica</b>			I.V.A: <b>23%</b>	
Marca: <b>Mader Home</b>			Ecorree: <b>0.00€</b>	Ecopilhas: <b>0.00€</b>
N. Ref. <b>68038</b>	Especificação <b>s/Terra - Tripla</b>	Quant. Caixa: <b>12 peças</b>		

## Suporte Lâmpada

### Soporte Aplique

### Bulb Frame



Descrição: <b>Suporte Lâmpada</b>			I.V.A: <b>23%</b>	
Marca: <b>Mader Home</b>			Ecorree: <b>0.00€</b>	Ecopilhas: <b>0.00€</b>
N. Ref. <b>68035</b>	Especificação <b>E27</b>	Quant. Caixa: <b>12 peças</b>		

## Ficha Eléctrica - Fêmea

### Clavija - Hembra

### Plug

**C/ TERRA**  
**TIERRA**  
**GROUNDLED**



Fêmea



Descrição: <b>Ficha Eléctrica</b>			I.V.A: <b>23%</b>	
Marca: <b>Mader Home</b>			Ecorree: <b>0.00€</b>	Ecopilhas: <b>0.00€</b>
N. Ref. Especificação	Quant. Caixa:			
<b>68037</b> c/ Terra - Fêmea	<b>12 peças</b>			

## Ficha Eléctrica - Macho

### Clavija - Macho

### Plug

**C/ TERRA**  
**TIERRA**  
**GROUNDLED**



Macho



Descrição: <b>Ficha Eléctrica</b>			I.V.A: <b>23%</b>	
Marca: <b>Mader Home</b>			Ecorree: <b>0.00€</b>	Ecopilhas: <b>0.00€</b>
N. Ref. Especificação	Quant. Caixa:			
<b>68036</b> c/ Terra - Macho	<b>12 peças</b>			

## Tomada Interior

### Enchufe Interior

### Socket

**C/ TERRA**  
**TIERRA**  
**GROUNDLED**



Descrição: <b>Tomada Interior</b>			I.V.A: <b>23%</b>	
Marca: <b>Mader Home</b>			Ecorree: <b>0.00€</b>	Ecopilhas: <b>0.00€</b>
N. Ref. Especificação	Quant. Caixa:			
<b>68030</b> c/Terra - Quadrada	<b>12 Peças</b>			

## Ficha Eléctrica - Tripla

### Clavija - Tripla

### Plug

**C/ TERRA**  
**TIERRA**  
**GROUNDLED**



Descrição: <b>Ficha Eléctrica</b>			I.V.A: <b>23%</b>	
Marca: <b>Mader Home</b>			Ecorree: <b>0.00€</b>	Ecopilhas: <b>0.00€</b>
N. Ref. Especificação	Quant. Caixa:			
<b>68040</b> c/Terra - Tripla	<b>12 peças</b>			

## Ficha Eléctrica - Fêmea

### Clavija - Hembra

### Plug

**C/ TERRA**  
**TIERRA**  
**GROUNDDED**

**PVC**



Fêmea



Descrição: **Fichas Eléctricas**

Marca: **Mader Home**

N. Ref. Especificação  
**68032 c/ Terra - Fêmea - PVC**

Quant. Caixa:  
**12 peças**

I.V.A: **23%**  
 Ecorree: **0.00€** Ecopilhas: **0.00€**

## Ficha Eléctrica - Macho

### Clavija - Macho

### Plug

**C/ TERRA**  
**TIERRA**  
**GROUNDDED**

**PVC**



Macho



Descrição: **Fichas Eléctricas**

Marca: **Mader Home**

N. Ref. Especificação  
**68031 c/ Terra - Macho - PVC**

Quant. Caixa:  
**12 peças**

I.V.A: **23%**  
 Ecorree: **0.00€** Ecopilhas: **0.00€**

## Interruptor - Passagem

### Interruptor - Pasaje

### Switch



Descrição: **Interruptor**

Marca: **Mader Home**

N. Ref. Especificação  
**68039 Passagem**

Quant. Caixa:  
**12 Peças**

I.V.A: **23%**  
 Ecorree: **0.00€** Ecopilhas: **0.00€**

## Ficha Eléctrica - Macho

### Clavija - Macho

### Plug

**C/ TERRA**  
**TIERRA**  
**GROUND**

# 90°



Descrição: **Fichas Eléctricas**

Marca: **Mader Home**

N. Ref. Especificação

Quant. Caixa:

**68041** c/ Terra - Macho - 90°

I.V.A:

**23%**

Ecorree: Ecopilhas:

**0.00€**

**0.00€**

## Ficha Eléctrica - Macho

### Clavija - Macho

### Plug

**C/ TERRA**  
**TIERRA**  
**GROUND**

**Borracha**  
**Goma**  
**Rubber**



Descrição: **Fichas Eléctricas**

Marca: **Mader Home**

N. Ref. Especificação

Quant. Caixa:

**68042** c/ Terra - Macho - Borracha

I.V.A:

**23%**

Ecorree: Ecopilhas:

**0.00€**

**0.00€**

## Ficha Eléctrica - Fêmea

### Clavija - Hembra

### Plug

**C/ TERRA**  
**TIERRA**  
**GROUND**

**Borracha**  
**Goma**  
**Rubber**



Descrição: **Interruptor**

Marca: **Mader Home**

N. Ref. Especificação

Quant. Caixa:

**68043** c/ Terra - Fêmea - Borracha

I.V.A:

**23%**

Ecorree: Ecopilhas:

**0.00€**

**0.00€**

## Pilhas Alcalinas

### Pilas Alcalinas

### Alkaline Batteries



**4 UN 1.5 V**

LR-03 - 4 pç



**4 UN 1.5 V**

LR-06 - 4 pç



**10 UN 1.5 V**

LR-06 - 10 pç



**2 UN 1.5 V**

LR-14 - 2 pç



Descrição: **Pilhas Alcalinas**

Marca: **Mader Home**

N. Ref. Especificação

Quant. Caixa:

68090 LR-03 - 4 pç

68091 LR-06 - 4 pç

68092 LR-06 - 10 pç

68093 LR-14 - 2 pç

I.V.A:

23%

Ecorree: Ecopilhas:

0.00€ 0.00€





**TINTAS  
PINTURAS  
INK**



**2013**



## Tinta Spray Multiusos

### Tinta para Usos Múltiples

### Normal Colour Spray Paint



Descrição: Tinta Spray

Marca: Mader Color

N. Ref. Especificação Quant. Caixa:

79403	Ref. 4 - 400ml	- Matt Black
79402	Ref. 6 - 400ml	- Orange Red
79432	Ref. 8 - 400ml	- Mars Red
79440	Ref. 11 - 400ml	- Naval Grey
79433	Ref. 12 - 400ml	- Grass Green
79434	Ref. 13 - 400ml	- Fresh Green
79435	Ref. 14 - 400ml	- Jialing Red
79422	Ref. 15 - 400ml	- Sky Blue
79441	Ref. 19 - 400ml	- Light Sky Blue
79407	Ref. 21 - 400ml	- Medium Blue
79442	Ref. 22 - 400ml	- Medium Grey
79409	Ref. 23 - 400ml	- Scarlet
79420	Ref. 25 - 400ml	- Medium Yellow
79443	Ref. 27 - 400ml	- Leaf Green
79421	Ref. 28 - 400ml	- Deep Blue
79444	Ref. 29 - 400ml	- Mission Brown



I.V.A:  
23%  
Ecorree: Ecopilhas:  
0.00€ 0.00€

## Tinta Spray Multiusos

### Tinta para Usos Múltiples

### Normal Colour Spray Paint

30



31



33



36



37



39



40



41



43

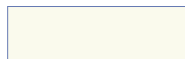

48



61



77



96



101



125



130



Descrição: Tinta Spray

Marca: Mader Color

N. Ref. Especificação Quant. Caixa:

79454	Ref. 30 - 400ml	- Peach Red
79445	Ref. 31 - 400ml	- Deep Yellow
79446	Ref. 33 - 400ml	- Cream Wellow
79404	Ref. 36 - 400ml	- Silver
79406	Ref. 37 - 400ml	- Light Green
79401	Ref. 39 - 400ml	- Black
79400	Ref. 40 - 400ml	- White
79419	Ref. 41 - 400ml	- Art Yellow
79436	Ref. 43 - 400ml	- Cream White
79437	Ref. 48 - 400ml	- Haier Grey
79405	Ref. 61 - 400ml	- Blackish Green
79447	Ref. 77 - 400ml	- Post Green
79448	Ref. 96 - 400ml	- Matt Black Grey
79455	Ref. 101 - 400ml	- Jade Green
79411	Ref. 125 - 400ml	- Silver Grey
79410	Ref. 130 - 400ml	- Pearl White

I.V.A:  
23%  
Ecorree: Ecopilhas:  
0.00€ 0.00€



## Tinta Spray Multiusos

### Tinta para Usos Múltiples

### Normal Colour Spray Paint

132



133



135



141

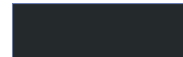

142



190

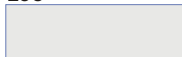

191

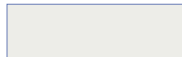

305



307



313



325



327



1007



Descrição: Tinta Spray

Marca: Mader Color

N. Ref. Especificação Quant. Caixa:

79438	Ref. 132 - 400ml - Bronze	
79408	Ref. 133 - 400ml - Diamond Blue	
79439	Ref. 135 - 400ml - Light Brown	
79412	Ref. 141 - 400ml - Deep Brown	
79418	Ref. 142 - 400ml - Anti-Rust Brown	
79456	Ref. 190 - 400ml - Laquer	
79457	Ref. 191 - 400ml - Matt Lacquer	
79449	Ref. 305 - 400ml - Refrigerator Green	
79450	Ref. 307 - 400ml - Matt Yellow White	
79458	Ref. 313 - 400ml - Light Pink	
79459	Ref. 325 - 400ml - Light Violet	
79462	Ref. 327 - 400ml - Deep Violet	
79451	Ref. 1007 - 400ml - Matt White	

I.V.A:  
23%  
Ecorree: Ecopilhas:  
0.00€ 0.00€

**Tinta Spray Multiusos**  
**Tinta para Usos Múltiples**  
**Normal Colour Spray Paint**

**FLUORESCENTE**  
**FLUORESCENT**

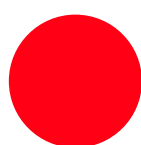

**1001**



**1002**

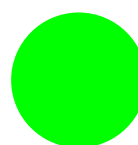

**1003**



**1004**



**1005**

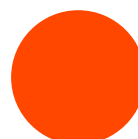

**1006**

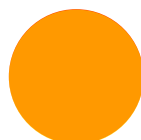

**1011**



Descrição: **Tinta Spray Fluorescente**

Marca: **Mader Color**

N. Ref.	Especificação
79423	Ref. 1001 - 400ml - Fluor. Red
79428	Ref. 1002 - 400ml - Fluor. Pink
79429	Ref. 1003 - 400ml - Fluor. Green
79452	Ref. 1004 - 400ml - Fluor. Blue
79424	Ref. 1005 - 400ml - Fluor. Yellow
79430	Ref. 1006 - 400ml - Fluor. Orange
79431	Ref. 1011 - 400ml - Fluor. Orange Yellow

I.V.A:  
**23%**  
 Ecorree: Ecopilhas:  
**0.00€ 0.00€**

**Tinta Spray Multiusos**  
**Tinta para Usos Múltiples**  
**Normal Colour Spray Paint**

**EFEITO OURO**  
**GOLD EFFECT**

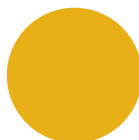

**Br. Gold - Ouro**



Descrição: **Tinta Spray**  
 Marca: **Mader Color**  
 N. Ref. Especificação Quant. Caixa:  
**79414 Ref. Br. Gold - 400ml - Ouro**

I.V.A:  
**23%**  
 Ecorree: Ecopilhas:  
**0.00€ 0.00€**

**Tinta Spray Multiusos**  
**Tinta para Usos Múltiples**  
**Normal Colour Spray Paint**

**EFEITO CROMADO**  
**CHROME EFFECT**



**Br. Crome - Cromado**



Descrição: **Tinta Spray**  
 Marca: **Mader Color**  
 N. Ref. Especificação Quant. Caixa:  
**79415 Ref. Br. Crome - 400ml - Cromado**

I.V.A:  
**23%**  
 Ecorree: Ecopilhas:  
**0.00€ 0.00€**

**Tinta Spray Multiusos**  
**Tinta para Usos Múltiples**  
**Normal Colour Spray Paint**

**EFEITO ZINCO**  
**ZINCO EFFECT**

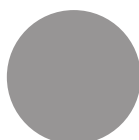

**Super Zinco**



Descrição: **Tinta Spray**  
 Marca: **Mader Color**  
 N. Ref. Especificação Quant. Caixa:  
**79453 Ref. Zinco - 400ml - Super Zinco**

I.V.A:  
**23%**  
 Ecorree: Ecopilhas:  
**0.00€ 0.00€**

## Tinta Spray Multiusos

### Tinta para Usos Múltiplos

### Normal Colour Spray Paint



63



1680

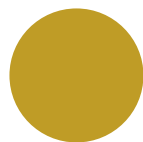

188



## SUPER METÁLICA

## SUPER METALLIC



63

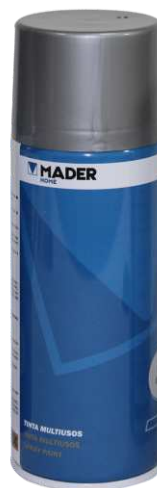

1680



188

Descrição: Tinta Spray

Marca: Mader Color

N. Ref. Especificação

79425 Ref. 63 - 400ml - Bright Silver

79426 Ref. 188 - 400ml - Ouro

79427 Ref. 1680 - 400ml - Prata

I.V.A:

23%

Ecorree: Ecopilhas:

0.00€ 0.00€

## Tinta Spray Multiusos

### Tinta para Usos Múltiplos

### Normal Colour Spray Paint

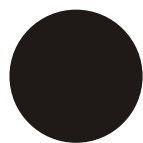

1200



1300



## ALTA TEMPERATURA

## HIGH TEMPERATURE



Descrição: Tinta Spray

Marca: Mader Color

N. Ref. Especificação

79416 Ref. 1200 - 400ml - High Temperature

79417 Ref. 1300 - 400ml - High Temperature

I.V.A:

23%

Ecorree: Ecopilhas:

0.00€ 0.00€

## Desengordurante para Motor

### Desengrasador para Motor

### Engine Degreaser



650ml

 Descrição: **Desengordurante para Motor**

 Marca: **Mader Color**

N. Ref. Especificação

**79483 Em Espuma - 650ml**

Quant. Caixa:

I.V.A:

**23%**

Ecorree: Ecopilhas:

**0.00€ 0.00€**

## Lubrificante Anti-Ferrugem

### Lubrificante Antiherrumbre

### Anti-Rust Lubricant



450ml

 Descrição: **Lubrificante**

 Marca: **Mader Color**

N. Ref. Especificação

**79481 Anti-Ferrugem - 450ml**

Quant. Caixa:

I.V.A:

**23%**

Ecorree: Ecopilhas:

**0.00€ 0.00€**

## Espuma Multiusos

### Espuma Multiusos

### All Purpose Foamy Cleaner



650ml

 Descrição: **Espuma**

 Marca: **Mader Color**

N. Ref. Especificação

**79482 Multiusos - 650ml**

Quant. Caixa:

I.V.A:

**23%**

Ecorree: Ecopilhas:

**0.00€ 0.00€**

## Cera para Superfícies em Pele

### Cera para Superfícies de Cuero

### Wax for Leather Surfaces



450ml

 Descrição: **Cera para Superfícies em Pele**

 Marca: **Mader Color**

N. Ref. Especificação

**79480 450 mm**

Quant. Caixa:

I.V.A:

**23%**

Ecorree: Ecopilhas:

**0.00€ 0.00€**

**Expositores**  
Expositores  
Exhibitors



Pequeno



EXPOSITOR VAZIO



Grande



EXPOSITOR VAZIO

Descrição: **Expositor p/ Tintas**

Marca: **Mader Color**

N. Ref. Especificação

79460 Pequeno - cap. 65 un (Vazio)

79461 Grande - cap. 114 un (Vazio)

I.V.A:

23%

Ecorree: Ecopilhas:

0.00€ 0.00€



**Tinta Industrial**  
Tinta Industrial  
Industrial Paint

**MATE BRANCA**  
**MATE BLANCO**  
**MATTE WHITE**



15L Mate



Descrição: **Tita Industrial**

Marca: **Mader Home**

N. Ref. Especificação

**80055 Mate Branca - 15L**

Quant. Caixa:

I.V.A:

**23%**

Ecorree: Ecopilhas:

**0.00€ 0.00€**





**GIALLO CROMO**  
Cod. 2201  
RAL 1007



**AVORIO**  
Cod. 2104  
RAL 1014



**BIANCO LUCIDO**  
Cod. 2101  
RAL 9010



**GIALLO CADMIO**  
Cod. 2203  
RAL 1021



**ARANCIO SCURO**  
Cod. 2205  
RAL 2002



**BIANCO OPACO**  
Cod. 2102  
RAL 9010



**ARANCIO PASTELLO**  
Cod. 2206  
RAL 2003



**ROSSO FUOCO**  
Cod. 2301  
RAL 3000



**TRASPARENTE OPACO**  
Cod. 2002



**ROSA CHIARO**  
Cod. 2302  
RAL 3015



**Tinta Spray Acrílico**  
**Spray Pintura Acrílico**  
**Acrylic Spray Paint**



**SECAGEM RÁPIDA**  
**SECADO RÁPIDO**  
**QUICK- DRYING**



**ROSSO TRAFFICO**  
Cod. 2304  
RAL 3020



**BLU ZAFFIRO**  
Cod. 2401  
RAL 5003



**TRASPARENTE LUCIDO**  
Cod. 2001



**BLU TRAFFICO**  
Cod. 2402  
RAL 5017



**BLU LUCE**  
Cod. 2403  
RAL 5012



**BIANCO ELETTRODOMESTICI**  
Cod. 900BE

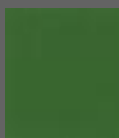

**VERDE PRIMAVERA**  
Cod. 2502  
RAL 6002



**VERDE MENTA**  
Cod. 2501  
RAL 6029



**ANTIRUGGINE GRIGIA**  
Cod. 2705



Descrição: **Tinta Spray - Acrílico**

Marca: **Solcolor**

N. Ref.	Especificação	
79603	Ref. 2201 - 400ml	- Giallo Cromo
79624	Ref. 2104 - 400ml	- Avorio
79629	Ref. 2101 - 400ml	- Bianco Lucido
79631	Ref. 2203 - 400ml	- Giallo Cadmio
79606	Ref. 2205 - 400ml	- Arancio Scuro
79622	Ref. 2102 - 400ml	- Bianco Opaco
79607	Ref. 2206 - 400ml	- Arancio Pastello
79608	Ref. 2301 - 400ml	- Rosso Fuoco
79621	Ref. 2002 - 400ml	- Trasparente Opaco
79609	Ref. 2302 - 400ml	- Rosa Chiaro
79637	Ref. 2304 - 400ml	- Rosso Traffico
79610	Ref. 2401 - 400ml	- Blu Zaffiro
79628	Ref. 2001 - 400ml	- Trasparente Lucido
79611	Ref. 2402 - 400ml	- Blu Traffico
79612	Ref. 2403 - 400ml	- Blu Luce
79600	Ref. 900BE - 400ml	- Bianco Elettrodomestici
79614	Ref. 2502 - 400ml	- Verde Primavera
79613	Ref. 2501 - 400ml	- Verde Menta
79619	Ref. 2705 - 400ml	- Antiruggine Grigia

I.V.A.:  
23%  
Ecorree: Ecopilhas:  
0.00€ 0.00€

**900 » 400mL**



## Tinta Spray Acrílico

### Spray Pintura Acrílico

### Acrylic Spray Paint

**SECAGEM RÁPIDA**  
**SECADO RÁPIDO**  
**QUICK- DRYING**

**900 » 400mL**



Descrição: **Tinta Spray - Acrílico**

Marca: **Solcolor**

N. Ref.	Especificação	
79615	Ref. 2503 - 400ml	- Verde Reseda
79632	Ref. 2701 - 400ml	- Grigio Argento
79618	Ref. 2702 - 400ml	- Grigio Chiaro
79620	Ref. 2706 - 400ml	- Grigio
79616	Ref. 2601 - 400ml	- Bruno Noce
79617	Ref. 2602 - 400ml	- Cioccolato
79602	Ref. 2802 - 400ml	- Nero Opaco
79601	Ref. 2801 - 400ml	- Nero Lucido

I.V.A:  
23%  
Ecorree: Ecopilhas:  
0.00€ 0.00€



VERDE  
RESEDA  
Cod. 2503  
RAL 6011



GRIGIO  
ARGENTO  
Cod. 2701  
RAL 7001



GRIGIO  
CHIARO  
Cod. 2702  
RAL 7035



GRIGIO  
Cod. 2706  
RAL 7030



BRUNO  
NOCE  
Cod. 2601  
RAL 8011



CIOCOLATO  
Cod. 2602  
RAL 8017

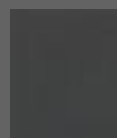

NERO  
OPACO  
Cod. 2802  
RAL 9005



NERO  
LUCIDO  
Cod. 2801  
RAL 9005



## Tinta Spray Acrílico

### Spray Pintura Acrílico

### Acrylic Spray Paint

**LINHA PARA CAIXILHARIAS**  
**LÍNEA PARA MARCO DE VENTANAS**  
**LINE FOR WINDOWS FRAMES**

**900 » 400mL**

Descrição: **Tinta Spray - Acrílico**

Marca: **Solcolor**

N. Ref.	Especificação	
79633	Ref. 2103 - 400ml	- Bianco Beige Perla
79634	Ref. 2303 - 400ml	- Rosso
79551	Ref. 2504 - 400ml	- Verde
79635	Ref. 2703 - 400ml	- Grigio Silicio

I.V.A:  
23%  
Ecorree: Ecopilhas:  
0.00€ 0.00€



BIANCO  
BEIGE PERLA  
Cod. 2103  
RAL 1013



ROSSO  
Cod. 2303  
RAL 3003



VERDE  
Cod. 2504  
RAL 6005

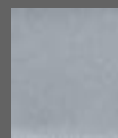

GRIGIO  
SILICIO  
Cod. 2703  
RAL 7032



**Tinta Spray - Efeitos Especiais**  
**Spray Pintura - Efectos Especiales**  
**Special Effects - Spray Paint**

**FLUORESCENTE**  
**FLUORESCENTE**  
**FLUORESCENT**

**907 » 400mL**



Descrição: **Tinta Spray - Fluorescente**

Marca: **Solcolor**

N. Ref.	Especificação	
79519	Ref. 907-2311 - 400ml	- Fluoresc Rosso
79520	Ref. 907-2211 - 400ml	- Fluoresc Giallo
79541	Ref. 907-2511 - 400ml	- Fluoresc Verde
79547	Ref. 907-2411 - 400ml	- Fluoresc Blu
79550	Ref. 907-2711 - 400ml	- Fluoresc Rosa
79534	Ref. 907-2611 - 400ml	- Fluoresc Arancio

I.V.A: **23%**  
 Ecorree: **0.00€** Ecopilhas: **0.00€**

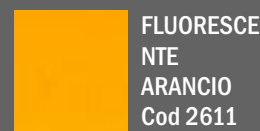
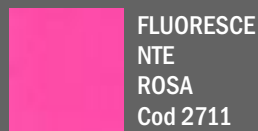

**Tinta Spray - Efeitos Especiais**  
**Spray Pintura - Efectos Especiales**  
**Special Effects - Spray Paint**

**METALIZADOS**  
**METALIZADO**  
**METALLIZED**

**902 » 400mL**



Descrição: **Tinta Spray - Metalizado**

Marca: **Solcolor**

N. Ref.	Especificação	
79652	Ref. 902- 400ml	- Argento
79654	Ref. 902- 400ml	- Rosso
79653	Ref. 902- 400ml	- Viola
79651	Ref. 902- 400ml	- Blu
79657	Ref. 902- 400ml	- Verde
79656	Ref. 902- 400ml	- Nero

I.V.A: **23%**  
 Ecorree: **0.00€** Ecopilhas: **0.00€**

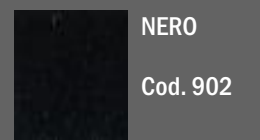
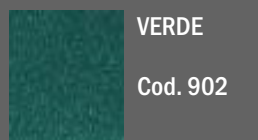
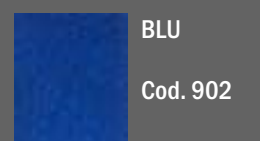
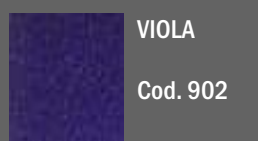
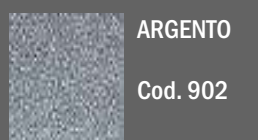

**Tinta Spray - Efeitos Especiais**  
**Spray Pintura - Efectos Especiales**  
**Special Effects - Spray Paint**

**CROMADO**  
**CROMADO**  
**CHROMED**

**907 » 400mL**



Descrição: **Tinta Spray - Cromado**

Marca: **Solcolor**

N. Ref.	Especificação
79544	Ref. 907-3007 - 400ml - Cromat Argento
79545	Ref. 907-3008 - 400ml - Cromat Oro

I.V.A:	23%
Ecorree:	0.00€
Ecopilhas:	0.00€

**Tinta Spray - Efeitos Especiais**  
**Spray Pintura - Efectos Especiales**  
**Special Effects - Spray Paint**

**DOURADOS**  
**DORADO**  
**GOLDEN**

**400mL**

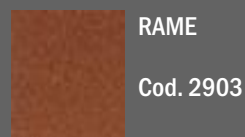
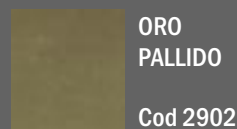
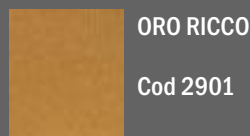

Descrição: **Tinta Spray - Dourado**

Marca: **Solcolor**

N. Ref.	Especificação
79536	Ref. 2901- 400ml - Oro Ricco
79537	Ref. 2902- 400ml - Oro Pallido
79538	Ref. 2905- 400ml - Argento
79529	Ref. 2903- 400ml - Rame

I.V.A:	23%
Ecorree:	0.00€
Ecopilhas:	0.00€



**Tinta Spray - Efeitos Especiais**  
**Spray Pintura - Efectos Especiales**  
**Special Effects - Spray Paint**

**ALTA TEMPERATURA**  
**ALTA TEMPERATURA**  
**HIGH TEMPERATURE**

**904 » 400mL**

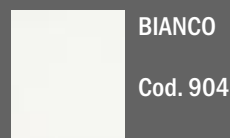
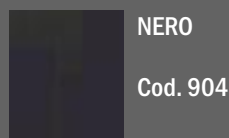

Descrição: **Tinta Spray - Alta Temperatura**

Marca: **Solcolor**

N. Ref.	Especificação
79518	Ref. 904- 400ml - Nero
79543	Ref. 904- 400ml - Bianco
79533	Ref. 904- 400ml - Argento

I.V.A:	23%
Ecorree:	0.00€
Ecopilhas:	0.00€



**Tinta Spray Acrílico**  
**Spray Pintura Acrílico**  
**Acrylic Spray Paint**

**AUTO**  
**AUTO**  
**AUTO**



**901 » 400mL**

Descrição: **Tinta Spray - Auto**

Marca: **Solcolor**

N. Ref.	Especificação
79630	Ref. 901- 400ml - Branco Lucido
79539	Ref. 901- 400ml - Branco Opaco
79623	Ref. 901- 400ml - Nero Lucido
79627	Ref. 901- 400ml - Nero Opaco
79625	Ref. 901- F/ 152 - 400ml - Rosso Vivo
79626	Ref. 901- F/ 120 - 400ml - Rosso Corsa
79655	Ref. 901- F/ 620 - 400ml - Alluminio Metalliz
79636	Ref. 901- F/ 690 - 400ml - Alluminio Ruote
79658	Ref. 901- F/ 279 - 400ml - Giallo Taxi

I.V.A.: **23%**  
 Ecorree: **0.00€**    Ecopilhas: **0.00€**

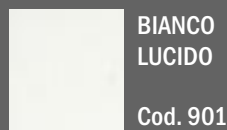

BIANCO  
LUCIDO

Cod. 901

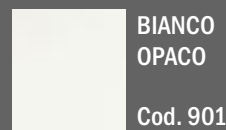

BIANCO  
OPACO

Cod. 901

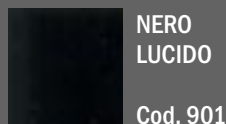

NERO  
LUCIDO

Cod. 901

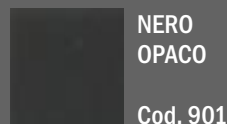

NERO  
OPACO

Cod. 901



ROSSO  
VIVO

Cod. F/152

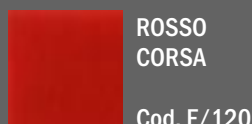

ROSSO  
CORSA

Cod. F/120



ALLUMINIO  
METALLIZATO

Cod. F/620

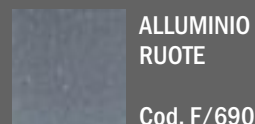

ALLUMINIO  
RUOTE

Cod. F/690

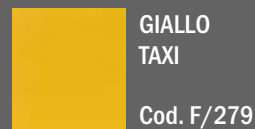

GIALLO  
TAXI

Cod. F/279



**Spray - Zinco**  
**Spray - Zinco**  
**Zinc - Spray**

**LINHA PROFISSIONAL**  
**LINEA PROFESIONAL**  
**PROFESSIONAL LINE**

**95% » 400mL**



Zinco  
95%  
  
Cod. 071



Descrição: **Spray - Zinco**

Marca: **Solcolor**

N. Ref.	Especificação
79505	Ref. 071 - 400ml

I.V.A.: **23%**  
 Ecorree: **0.00€**    Ecopilhas: **0.00€**

Spray de zinco é 95% composto de zinco puro, o que garante uma protecção completa de todos os tipos de superfícies metálicas.

Spray ZINC es 95% compuesto de zinc puro, que garantiza la protección completa de todo tipo de superficies metálicas.

ZINC Spray is over 95% made up of pure zinc, thus it ensures a complete protection of all kinds of metallic surfaces.

Spray - Óleo  
Spray - Aceite  
Oil - Spray

**LINHA TECNICA**  
**LINEA TÉCNICA**  
**TECHNICAL LINE**

**400mL**



Olio Lubrificante Spray  
VAS 2

Cod. 012



Lubrificante protector para uso geral. É incolor, inodoro, não-tóxico e não mancha. Para uso industrial e também na indústria de alimentos.

Lubricante de protección de uso general, es incoloro, inodoro, no tóxico y no mancha. Útiles para uso industrial, también en la industria alimentaria.

Protective lubricant of general use; it is colourless, odourless, non-toxic and will not stain. Useful for industrial use, also in the food industry

Descrição: Óleo Spray

Marca: Solcolor

N. Ref. Especificação

79504 Ref. 012 - 400ml - VAS 2

I.V.A:

23%

Ecorree: Ecopilhas:

0.00€ 0.00€

Spray - Óleo  
Spray - Aceite  
Oil - Spray

**LINHA TECNICA**  
**LINEA TÉCNICA**  
**TECHNICAL LINE**

**150mL**  
**400mL**



SBLOCCANTE Spray  
TECNOSBLOCK  
Cod. 001  
150 mL

SBLOCCANTE Spray  
TECNOSBLOCK  
Cod. 076  
400 mL



Limpa rápida e facilmente todas as partes metálicas oxidadas dissolvendo a ferrugem e eliminando depósitos de impurezas. Penetra rapidamente possibilitando um afrouxamento imediato de porcas, parafusos, etc.

Limpia rápido y sencilla todas las partes metálicas oxidadas por disolución de óxido y la eliminación de depósitos de impurezas. Penetra rapidamente permitiendo una relajación inmediata de las tuercas, pernos, etc

Descrição: Óleo Spray

Marca: Solcolor

N. Ref. Especificação

79500 Ref. 001 - 150ml - Tecnosblok

79522 Ref. 076 - 400ml - Tecnosblok

I.V.A:

23%

Ecorree: Ecopilhas:

0.00€ 0.00€

Spray - Óleo  
Spray - Aceite  
Oil - Spray

**LINHA TECNICA**  
**LINEA TÉCNICA**  
**TECHNICAL LINE**

**150mL**  
**400mL**



GRASSO MULTIUSO  
Spray  
Cod. 002  
150 mL

GRASSO MULTIUSO  
Spray  
Cod. 039  
400 mL



Lubrificante de uso geral e longa duração com anti-desgaste elevado e propriedades anti-corrosão. Com características repelentes de água, pode também ser aplicado em superfícies húmidas.

Lubricante de uso general y de larga duración con el antidesgaste elevado y propiedades anticorrosivas. Con características repelentes del agua, también se puede aplicar sobre superficies húmedas.

Descrição: Óleo Spray

Marca: Solcolor

N. Ref. Especificação

79501 Ref. 002 - 150ml - Grasso

79506 Ref. 039 - 400ml - Grasso

I.V.A:

23%

Ecorree: Ecopilhas:

0.00€ 0.00€

Spray - Óleo  
 Spray - Aceite  
 Oil - Spray

**LINHA AUTO  
 LINEA AUTO  
 AUTO LINE**

**150mL**



WATER-REPELLENT  
 ANTIHUMIDITY

Cod. 005



Protege e repele humidade de sistemas elétricos.  
 Evita dispersões elétricas.

Protege y repele la humedad de los sistemas eléctricos.  
 Se evita dispersiones eléctricos.

It protects and repels humidity from electric systems.  
 It avoids electric dispersions.

Descrição: Óleo Spray

Marca: Solcolor

N. Ref. Especificação

79502 Ref. 005 - 150ml - Idrorepellente

I.V.A:

23%

Ecorree: Ecopilhas:

0.00€ 0.00€

Spray - Detergente  
 Spray - Detergente  
 Detergent - Spray

**LINHA AUTO  
 LINEA AUTO  
 AUTO LINE**

**400mL**



PULIPLAST - PULITORE  
 PER CRUSCOTTI

Cod. 074  
 400 mL



Limpa e dá brilho a placas de instrumentos, todos os tipos de  
 borracha e superfícies plásticas do carro.

Limpia y da brillo a las placas de los instrumentos, todos los tipos de  
 superficies de goma y plástico del coche.

Cleans and brightens the plates of instruments, all types of rubber  
 and plastic surfaces of the car.

Descrição: Detergente Spray

Marca: Solcolor

N. Ref. Especificação

79513 Ref. 074 - 400mL - Puliplast

I.V.A:

23%

Ecorree: Ecopilhas:

0.00€ 0.00€

Spray - Buzina Acústica Ecológica  
 Spray - Bocina Acústica Ecológica  
 Ecological Acoustic Horn - Spray

**LINHA TECNICA  
 LINEA TÉCNICA  
 TECHNICAL LINE**

**250mL**



TROMBA ACUSTICA  
 Ecologic - Completa  
 Cod. 624  
 250 mL

TROMBA ACUSTICA  
 Ecologic - Recarga  
 Cod.  
 250 mL



Acessório útil para usos náuticos, desportivos, festas e carnaval.  
 Com um som poderoso é audível a uma longa distância.

Útil accesorio para los deportes náuticos, festivales y carnavales.  
 Con un potente sonido se escucha a una gran distancia.

Useful accessory for road and nautical uses, sport, parties and  
 Carnival. Its very powerful sound makes it audible from very long  
 distance.

Descrição: Buzina Acústica Ecológica Spray

Marca: Solcolor

N. Ref. Especificação

79532 Ref. 624 - 250ml - Buzina Completa

79552 Ref. - 250ml - Recarga

I.V.A:

23%

Ecorree: Ecopilhas:

0.00€ 0.00€

**Trincha**  
**Paletina**  
**Paint Brush**

**1" / 25 mm**

**1.5" / 38 mm**

**2" / 50 mm**

**2.5" / 63 mm**

**3" / 75 mm**

**4" / 100 mm**

 Descrição: **Trincha - Cabo Bicolor**

 Marca: **Mader Home**

N. Ref. Especificação

Quant. Caixa:

**88260** 1" - 25 mm

**88261** 1.5" - 38 mm

**88262** 2" - 50 mm

**88263** 2.5" - 63 mm

**88264** 3" - 75 mm

**88265** 4" - 100 mm

I.V.A:

**23%**

Ecorree: Ecopilhas:

**0.00€ 0.00€**

## Trincha Paletina Paint Brush

**3 un.**

3 un. » 25, 35, 50 mm



Descrição: <b>Trincha</b>	I.V.A:	
Marca: <b>Mader Home</b>	<b>23%</b>	
N. Ref. Especificação	Ecorree:	Ecopilhas:
<b>68111 25, 35, 50 mm - 3 Peças</b>	<b>0.00€</b>	<b>0.00€</b>

## Trincha Paletina Paint Brush

**10 un.**

2 x 13mm  
2 x 25mm  
2 x 38mm  
2 x 50mm  
2 x 63mm



Descrição: <b>Trincha</b>	I.V.A:	
Marca: <b>Mader Color</b>	<b>23%</b>	
N. Ref. Especificação	Ecorree:	Ecopilhas:
<b>88250 cabo madeira - 10 Peças</b>	<b>0.00€</b>	<b>0.00€</b>

## Esfregão de Aço Estropajo de Acero Steel Wool



Descrição: <b>Esfregão de Aço</b>	I.V.A:	
Marca: <b>Mader Home</b>	<b>23%</b>	
N. Ref. Especificação	Ecorree:	Ecopilhas:
<b>68140 Esfregão Palha</b>	<b>0.00€</b>	<b>0.00€</b>

## Rolos de Pintura Rodillos de Pintura Paint Roll



100mm - Anti Gota



230mm - Anti Gota



100mm - Lã



230mm - Lã



Descrição: Rolo de Pintura

Marca: Mader Home

N. Ref. Especificação Quant. Caixa:

68101 100 x 11 mm - Anti-Gota

68100 230 x 11 mm - Y-502+HS-2001C - Anti-Gota

68103 100 x 5 mm - Lã

68102 230 x 7 mm - Lã - Y-502+HS-2015C

I.V.A:

23%

Ecorree: Ecopilhas:

0.00€

0.00€

## Rolo de Pintura + Cabo Extensível Rodillo + Mango Paint Roller + Extended Cable

**CABO 1.3m**  
**MANGO 1.3m**  
**CABLE 1.3m**



9" » 230 mm



800 mm a 1300mm

9"



Descrição: Rolo Pintura + Cabo Extensível

Marca: Mader Home

N. Ref. Especificação Quant. Caixa:

88236 230 mm » 9" + cabo 1.30 m

I.V.A:

23%

Ecorree: Ecopilhas:

0.00€

0.00€

## Conjunto de Pintura

### Juego de Pintura

### Paint Set



- 1 - Tabuleiro / Tablero / Board
- 1 - Trincha 5cm / Pincel / Brush
- 2 - Rolos / Rodillo / Rolls
- 1 - Cabo / Cable / Handle



Descrição: **Conjunto de Pintura**

Marca: **Mader Home**

N. Ref. Especificação  
**68106 100 cm - 5 Peças**

Quant. Caixa:

I.V.A:

**23%**

Ecorree: Ecopilhas:

**0.00€**

**0.00€**

## Conjunto de Pintura

### Juego de Pintura

### Paint Set



- 1 - Tabuleiro / Tablero / Board
- 1 - Trincha 5cm / Pincel / Brush
- 2 - Rolos / Rodillo / Rolls
- 1 - Cabo / Cable / Handle



Descrição: **Conjunto de Pintura**

Marca: **Mader Home**

N. Ref. Especificação  
**68107 230 mm - 5 peças**

Quant. Caixa:

I.V.A:

**23%**

Ecorree: Ecopilhas:

**0.00€**

**0.00€**

## Conjunto de Pintura

### Juego de Pintura

### Paint Set



Descrição: **Conjunto de Pintura**

Marca: **Mader Home**

N. Ref. Especificação  
**68109 10 Peças**

Quant. Caixa:

I.V.A:

**23%**

Ecorree: Ecopilhas:

**0.00€ 0.00€**

## Conjunto de Pintura

### Juego de Pintura

### Paint Set



Descrição: **Conjunto de Pintura**

Marca: **Mader Home**

N. Ref. Especificação  
**68110 15 Peças**

Quant. Caixa:

I.V.A:

**23%**

Ecorree: Ecopilhas:

**0.00€ 0.00€**

**Tabuleiro**  
**Tablero**  
**Paint Board**



100mm

230mm



Descrição: <b>Tabuleiro Pintura</b>		
Marca: <b>Mader Home</b>		
N. Ref.	Especificação	Quant. Caixa:
68104	100 mm	
68105	230 mm	

I.V.A:	23%
Ecorree:	0.00€
Ecopilhas:	0.00€

**Balde Pintura**  
**Cubo de Pintura**  
**Paint Bucket**



Descrição: <b>Balde de Pintura</b>		
Marca: <b>Mader Home</b>		
N. Ref.	Especificação	Quant. Caixa:
68108	12 L - c/Grelha	

I.V.A:	23%
Ecorree:	0.00€
Ecopilhas:	0.00€

**Misturador**  
**Mezclador**  
**Mixer**



Descrição: <b>Misturador de Cola / Tinta</b>		
Marca: <b>Mader Home</b>		
N. Ref.	Especificação	Quant. Caixa:
52420	80 x 400 mm cromado	
52425	120 x 600 mm	

I.V.A:	23%
Ecorree:	0.00€
Ecopilhas:	0.00€

## Silicone Silicona Silocon



**Prego invisível  
Transparente**



**Prego invisível  
Branco**

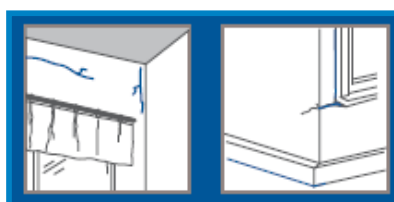

**Restaurador  
Branco**

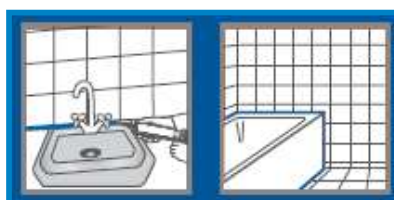

**100% Silicone  
Transparente**



**100% Silicone  
Branco**



Descrição: **Silicone**

Marca: **Mader Home**

N. Ref.	Especificação	Quant. Caixa:
62600	Prego Invisível/Transparente	12
62601	Prego Invisível/Branco	12
62610	Restaurador Branco	12
62640	100% Silicone Transparente	12
62641	100% Silicone Branco	12

I.V.A.:  
**23%**  
Ecorree: Ecopilhas:  
**0.00€ 0.00€**

## Silicone Silicona Silon



**Vedante  
Branco**



**Vedante  
Verde Escuro**



**Vedante  
Cinzento**

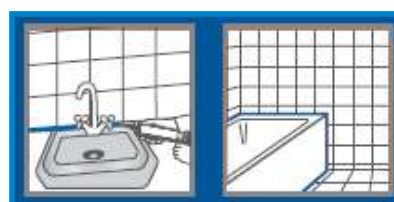

**Cola e Veda**



**Cozinha/WC**



Descrição: **Silicone**

Marca: **Mader Home**

N. Ref.	Especificação	Quant. Caixa:
62620	Vedante Branco	12
62621	Vedante Verde Esc	12
62622	Vedante Cinzento	12
62623	Cola e Veda - Transparente	12
62630	Cozinha/WC Branco	12

I.V.A.:  
**23%**  
Ecorree: Ecopilhas:  
**0.00€ 0.00€**

**Cola de Contacto**  
**Cola de Contacto**  
**Contacto Glue**

**30ml**

**2un.**



**2un**



Descrição: **Cola Contacto**

Marca: **Mader Home**

N. Ref. Especificação  
**68135 2un - 30ml**

Quant. Caixa:

I.V.A:

**23%**

Ecorree: Ecopilhas:

**0.00€ 0.00€**



## Super Cola Adhesivo Instantaneo Super Glue

Super Cola  
Madeira, Plástico, Cerâmica, Metal e Borracha

Super Pegamento  
Madera, Plástico, Cristal, Metal e Caucho

Superglue  
Wood, Plastics, Ceramics, Metal and Rubber

3g

3un.



Descrição: **Super Cola**

Marca: **Mader Fix**

N. Ref. Especificação  
10011 3 gr. - 3 un.

Quant. Caixa:

I.V.A:

23%

Ecorree: Ecopilhas:  
0.00€ 0.00€

## Super Cola Adhesivo Instantaneo Super Glue

Super Cola  
Madeira, Plástico, Cerâmica, Metal e Borracha

Super Pegamento  
Madera, Plástico, Cristal, Metal e Caucho

Superglue  
Wood, Plastics, Ceramics, Metal and Rubber

3g

6un.



Descrição: **Super Cola**

Marca: **Mader Fix**

N. Ref. Especificação  
10010 3 gr. - 6 un.

Quant. Caixa:

I.V.A:

23%

Ecorree: Ecopilhas:  
0.00€ 0.00€

## Super Cola Adhesivo Instantaneo Super Glue

Super Cola  
Madeira, Plástico, Cerâmica, Metal e Borracha

Super Pegamento  
Madera, Plástico, Cristal, Metal e Caucho

Superglue  
Wood, Plastics, Ceramics, Metal and Rubber

3g

12un.



Descrição: **Super Cola**

Marca: **Mader Fix**

N. Ref. Especificação  
10012 3 gr. - 12 un.

Quant. Caixa:

I.V.A:

23%

Ecorree: Ecopilhas:  
0.00€ 0.00€

**Expositor - Super Cola**  
**Expositor - Adhesivo Instantâneo**  
**Display - Super Glue**

20g

25un.

**ideal para colar diversas superfícies como:**  
**madeira, metal, alguns plásticos, porcelana, couro, papel e cartão**

**ideal para pegar variadas superficies como:**  
**madera, metal, algunos plásticos, china, cuero, papel y cartón**

**ideal for bonding many surfaces including:**  
**wood,metal,some plastics,porcelain,leather,paper and card**



Exp. - 25un



Descrição: **Super Cola**

Marca: **Mader Fix**

N. Ref. Especificação

10019 Expositor - 25 Peças - 20g

Quant. Caixa:

I.V.A:

23%

Ecorree: Ecopilhas:

0.00€ 0.00€



**Spray Lubrificante**  
**Spray Lubrificante**  
**Lubricant Spray**

**200 ml**

**200 ml + 20 ml**

**400 ml**

Descrição: Óleo Lubrificante

 Marca: **WD 40**

N. Ref. Especificação

**25022** 200 ml

**25017** 200 ml + 20 ml

**25024** 400 ml

Quant. Caixa:

I.V.A:

**23%**

Ecorree: Ecopilhas:

**0.00€ 0.00€**
**Spray Lubrificante**  
**Spray Lubrificante**  
**Lubricant Spray**
**COM PULVERIZADOR**  
**CON POLVERIZADOR**  
**WITH SPRAYER**

**500 ml**

Descrição: Óleo Lubrificante

 Marca: **WD 40**

N. Ref. Especificação

**25025** 500 ml

Quant. Caixa:

I.V.A:

**23%**

Ecorree: Ecopilhas:

**0.00€ 0.00€**
**Óleo**  
**Aceite**  
**Oil**

**5 L**

Descrição: Óleo Lubrificante

 Marca: **WD 40**

N. Ref. Especificação

**25026** 5L c/Pulverizador

Quant. Caixa:

I.V.A:

**23%**

Ecorree: Ecopilhas:

**0.00€ 0.00€**

## Produtos Auto Productos Auto Car Products



Descrição: **Produtos Auto**

Marca: **Eco**

N. Ref. Especificação Quant. Caixa:

25101 Abrihantador Pneus - 500 ml

25100 Abrihantador Pneus - 1 L

25108 Limpa Tablier - 500 ml

25109 Limpa Tablier - 1 L

25114 Limpa Estofos - 500 ml

25115 Limpa Estofos - 1 L

25116 Limpa Jantes - 500 ml

25117 Limpa Jantes - 1 L

I.V.A:

23%

Ecorree: Ecopilhas:

0.00€ 0.00€

0.00€

500 mL-Abrilh



500 mL-Estofos



1 L-Estofos



1 L-Abrilh



500 mL-Jantes



500 mL-Tablier



1 L-Jantes



1 L-Tablier



## Produtos Auto Productos Auto Car Products



Descrição: **Produtos Auto**

Marca: **Eco**

N. Ref. Especificação Quant. Caixa:

25102 Limpa Vidros - 1 L

25104 Limpa Vidros - 2 L

25103 Limpa Vidros - 5 L

25105 Champô Auto - 1 L

25113 Champô Auto - 2 L

25107 Champô Auto - 5 L

25110 Anti-Congelante - 1 L

25111 Anti-Congelante - 2 L

25112 Anti-Congelante - 5 L

I.V.A:

23%

Ecorree: Ecopilhas:

0.00€ 0.00€

0.00€

1 L - Vidros



1 L - Champô



2 L - Vidros



2 L - Champô



5 L - Vidros



5 L - Champô



1 L - Anti-Congelante



5 L - Anti-Congelante



2 L - Anti-Congelante



**Recarga Gás**  
**Cartucho Gas**  
**Cartridge Gas**

**Butano**



**Propano**



Descrição: **Recarga Gás**

Marca: **Mader Home**

N. Ref. Especificação

**67015 190g**

**67014 KEM - 190g**

Quant. Caixa:

| **36**

| **36**

I.V.A:

**23%**

Ecorree: Ecopilhas:

**0.00€**

**0.00€**



## Mini-Tocha

### Mini Antorcha

### Mini Torch

**QUEIMADOR MULTIUSOS**  
**QUEMADOR MULTIUSOS**  
**MULTIPURPOSE BURNER**

### Mini Tocha

Temperatura da chama » **1000° C**  
Capacidade Gaz » **6 mL**  
**Recarregável**  
**Chama Precisa**



**1000°C**



Descrição: <b>Mini Tocha</b>		I.V.A:	
Marca: <b>PRV</b>		<b>23%</b>	
N. Ref. Especificação	Quant. Caixa:	Ecorree:	Ecopilhas:
<b>67513</b> <b>Multiusos - PVR100</b>		<b>0.00€</b>	<b>0.00€</b>

## Recarga Gás

### Cartucho Gas

### Cartridge Gas

### Universal

**100% Butano**  
Bicos adaptáveis » **5**



Recarga » **52 gr. / 80 mL**



**80 mL**



Descrição: <b>Recarga Gás</b>		I.V.A:	
Marca: <b>PRV</b>		<b>23%</b>	
N. Ref. Especificação	Quant. Caixa:	Ecorree:	Ecopilhas:
<b>67514</b> <b>p/ PRV100 - CGR052 - 80 mL</b>		<b>0.00€</b>	<b>0.00€</b>

**Aquecedor de Esplanada**  
**Calentador Tipo Hongo**  
**Outdoor Heater**



INOX

- . Potência Mínima/  
Potencia Mínima/  
Minimum Power:  
**5000W**
- . Potência Máxima/  
Potencia Máxima/  
Maximum Power:  
**12000W**
- . Consumo/Consumo/Flux:  
**450g - 870g/h**
- . Combustível/Carburante/Fuel:  
Apenas Gás Propano ou Butano/  
Solo Gas Propano ou Butano/  
Butane or Propane Gas Only
- . Altura Total/  
Altura Total/  
Total Height:  
**2210mm**
- . Peso/Peso/Weight:  
**21Kg**

**CINZENTO BRILHANTE**  
**GRIS BRILLANTE**  
**BRIGHT GREY**



**VERDE ESCURO**  
**VERDE OSCURO**  
**DARK GREEN**



**AÇO INOXIDÁVEL**  
**ACERO INOXIDABLE**  
**STAINLESS STEEL**



Descrição: **Aquecedor de Esplanada**

Marca: **Mader Home**

N. Ref. Especificação Quant. Caixa:

68161 HMXD-A - 12000W - Cinzento

68160 HMXD-A - 12000W - Verde

68162 HMXD-B - 12000W - Inox

I.V.A:

23%

Ecorree: Ecopilhas:

0.00€ 0.00€

**Cobertura para Aquecedor de Esplanada**  
Cobertura para Calentador Tipo Hongo  
Outdoor Heater Cover

**PEQUENA**  
**PEQUEÑA**  
**SMALL**



Descrição: **Cobertura para Aquecedor de Esplanada**

Marca: **Mader Home**

N. Ref. Especificação  
**68165 Pequena**

Quant. Caixa:

I.V.A:

**23%**

Ecorree: Ecopilhas:  
**0.00€ 0.00€**

**Cobertura para Aquecedor de Esplanada**  
Cobertura para Calentador Tipo Hongo  
Outdoor Heater Cover

**GRANDE**  
**GRANDE**  
**BIG**



Descrição: **Cobertura para Aquecedor de Esplanada**

Marca: **Mader Home**

N. Ref. Especificação  
**68166 Grande**

Quant. Caixa:

I.V.A:

**23%**

Ecorree: Ecopilhas:  
**0.00€ 0.00€**

## Estufa » Pellets

### Estufa » Pellets

### Pellet Stove

**PS-50**
**9.5-13.5KW**

- . Potência Térmica Mínima/Potencia Térmica Mínima/Minimum Thermal Power: 9.5Kw
- . Potência Térmica Máxima/Potencia Térmica Máxima/Maximum Thermal Power: 13.5Kw
- . Saída de Aquecimento/Salida de Calentamiento/Heating Power: 46000BTU
- . Consumo de Pellets/Consumo de Pellets/Pellet Consumption: 0.6-1.2Kg/h
- . Rendimento/Rendimiento/Efficiency: 80%
- . Saída de Fumos/Tubo de Entrada/Salida Humos/Toma Aire Exterior/Smoke Outlet/Inlet Pipe: Ø80/50mm
- . Capacidade do Depósito/Capacidad Tolva Pellets/Pellet Tank Capacity: 16Kg
- . Autonomia/Autonomía/Runtime: 14/26h
- . Área de Aquecimento/Area de Calentamiento/Heating Area: 60-100m<sup>2</sup>
- . Potência de Entrada/Potencia de Entrada/Power Input: 400W
- . Peso/Peso/Weight: 88Kg
- . Dimensões/Dimensiones/Size: 485x570x940mm
- . Características/Características/Features:  
 Controlo Remoto/Mando Remoto/Remote Control  
 Acendimento Automático/Acendimiento Automático/Auto-Igniter  
 Auto-Limpeza com Aspiração/Autolimpieza con Aspiración/Automatic Dust-Cleaning  
 Auto-Controlo da Temperatura/Autocontrol de la Temperatura/Auto-Control on Temperature



#### Vantagem destes equipamentos:

Inodoro

Ecológico, as Pellets são feitas de aparas de madeira e/ou de limpezas de matas

O poder de aquecimento é 3vezes superior ao da lenha

Fácil manutenção, poucas cinzas criadas



Descrição: **Estufa » Pellets**

Marca: **Mader Home**

N. Ref. Especificação

**68170 PS-50 - 9.5-13.5Kw**

Quant. Caixa:

I.V.A:

**23%**

Ecorree: Ecopilhas:

**0.00€ 0.00€**

## Pellets / Pellets / Pellet

O combustível verde do futuro, para caldeiras domesticas e industriais, salamandras e recuperadores de calor

- Benefícios - Limpo (emissões neutras de CO2),
- Renovável (aproveita resíduos florestais e de madeira),
- Económico: PCI: 2.0 kg peletes = 1 litro gasóleo,  
2.5 kg peletes = 1kg gás propano,
- Automático (substitui o gasóleo e gás de aquecimento)



Descrição: **Pellets**

Marca: **Mader Home**

N. Ref. Especificação

**68172 6 mm - Saco de 15 Kg**

Quant. Caixa:

I.V.A:

**23%**

Ecorree: Ecopilhas:

**0.00€ 0.00€**



**Termoventilador**  
**Termoventilador**  
**Fan Heater**

**PTC-2000**

**1000W-2000W**

**PAREDE**  
**PARED**  
**WALL**

**AMBIENTE/QUENTE**  
**AMBIENTE/CALIENTE**



. Potência/Potencia/Power:  
**1000W/2000W**

. Características/  
 Características/  
 Features:

**Controlo Remoto/  
 Mando a Distancia/  
 Remote Control**

**Temporizador de 7.5 horas/  
 Temporizador de 7.5 horas/  
 7.5 hours Timer**

**3 Opções de Ventilação:  
 Frio, Ambiente e Quente/  
 Frío, Ambiente y Caliente/  
 Cold, Warm and Hot**

**Palas de Oscilação Automática/  
 Veletas de Oscilación Automática/  
 Automatic Oscillation Louvers**

**Função Oscilação do Ar/  
 Función Oscilación del Aire/  
 Swing Air Function**

.Tensão/Tensión/Tension:  
**220-240V/50Hz**

.Dimensões/Dimensiones/Size:  
**650x160x240mm**

.Peso/Peso/Weight:  
**4.2Kg**



Descrição: **Termoventilador**

Marca: **Mader Home**

N. Ref. Especificação Quant. Caixa:  
**16052 p/ Parede - 1000 / 2000 W**

I.V.A:

**23%**

Ecorree: Ecopilhas:

**0.20€ 0.00€**



## Termoventilador

### Termoventilador

### Fan Heater

**1000/2000W** **FH-90B**

- Com pega de transporte
- Regulação do termóstato
- Ajuste para ventilação
- Selector de potência
- Protecção contra sobreaquecimento
- Indicador luminoso de funcionamento
- Con manija de transporte
- Regulación del termostato
- Ajuste para ventilación
- Selector de potencia
- Protección contra sobrecalentamiento
- Indicador luminoso de funcionamiento
- Integral carry handle
- Adjustable thermostat control
- Cool blow
- 2 Heat settings
- Overheat protection
- Indicator light

 Descrição: **Termoventilador**

 Marca: **Mader Home**

 N. Ref. Especificação  
**16050 1000 / 2000 W**

Quant. Caixa:

I.V.A:

**23%**

 Ecorree: Ecopilhas:  
**0.04€ 0.00€**

## Termoventilador

### Termoventilador

### Fan Heater

**1000/2000W** **KFH-901**

- Com pega de transporte
- Regulação do termóstato
- Ajuste para ventilação
- Selector de potência
- Protecção contra sobreaquecimento
- Indicador luminoso de funcionamento
- Con manija de transporte
- Regulación del termostato
- Ajuste para ventilación
- Selector de potencia
- Protección contra sobrecalentamiento
- Indicador luminoso de funcionamiento
- Integral carry handle
- Adjustable thermostat control
- Cool blow
- 2 Heat settings
- Overheat protection
- Indicator light

 Descrição: **Termoventilador**

 Marca: **Mader Home**

 N. Ref. Especificação  
**16051 1000 / 2000 W**

Quant. Caixa:

I.V.A:

**23%**

 Ecorree: Ecopilhas:  
**0.04€ 0.00€**

## Termoventilador Termoventilador Fan Heater

**FH-90E**
**1000W-2000W**

. Potência/Potencia/Power:  
1000W/2000W  
. Características/Características/Features:  
Selector de Potência/Selector de Potencia/Power Selector  
Termóstato Regulável/Termostato Ajustable/  
Adjustable Thermostat  
Protecção contra Sobreaquecimento/  
Protección contra Sobrecalentamiento/  
Overheating Protection  
Portátil/Portable/Portable  
Resistente a Altas Temperaturas/  
Resistente a Altas Temperaturas/  
High Temperature Resistant  
Estrutura em Plástico/Estructura en Plástico/Plastic Frame  
Luz de Funcionamento/Luz de Funcionamiento/  
Power Indicator Light  
Sistema Oscilante/Sistema Oscilante/  
Swinging Function  
.Tensão/Tensión/Tension:  
220-240V/50Hz  
.Dimensões/Dimensiones/Size:  
225x205x310mm  
.Peso/Peso/Weight:  
1.88Kg



**OSCILANTE  
OSCILANTE  
SWINGING**



Descrição: **Termoventilador**  
Marca: **Mader Home**  
N. Ref. Especificação  
**16053 Oscilante - 1000 / 2000 W**

Quant. Caixa:

I.V.A:  
**23%**  
Ecorree: Ecopilhas:  
**0.09€ 0.00€**

## Convector Convector Convector Heater

**CH-2000A**
**750W-2000W**

. Potência/Potencia/Power:  
750W/1250W/2000W  
. Características/  
Características/  
Features:  
Termóstato Regulável/  
Termostato Ajustable/  
Adjustable Thermostat  
Protecção contra Sobreaquecimento/  
Protección contra Sobrecalentamiento/  
Overheating Protection  
Duplo Isolamento/  
Doble Aislamiento/  
Double Insulation  
Luz de Funcionamento/  
Luz de Funcionamiento/  
Power Indicator Light  
.Tensão/Tensión/Tension:  
220-240V/50Hz  
.Dimensões/Dimensiones/Size:  
625x140x440mm  
.Peso/Peso/Weight:  
3.4Kg



Descrição: **Convector Turbo**  
Marca: **Mader Home**  
N. Ref. Especificação  
**16025 750 W / 2000 W**

Quant. Caixa:

I.V.A:  
**23%**  
Ecorree: Ecopilhas:  
**0.16€ 0.00€**



## Radiador Quartzo Calentador Cuarzo Quartz Heater

400/800W

QH - 90D

- Estrutura em plástico
- Com pega de transporte
- Selector de potência
- Resistente a altas temperaturas
- Protecção contra sobreaquecimento
- Baixo consumo

- Armazón en plástico
- Con manija de transporte
- Selector de potencia
- Resistente a altas temperaturas
- Protección contra sobrecalentamiento
- Bajo consumo

- Plastic body
- With handle
- 3 Heating powers
- High temperature resistant
- Safety tip-over switch
- Energy saving



Descrição: Radiador Quartzo

Marca: Mader Home

N. Ref. Especificação

16062 400 / 800 W

Quant. Caixa:

I.V.A:

23%

Ecorree: Ecopilhas:

0.06€ 0.00€

## Radiador Halgéneo Calentador Halogeno Halogen Heater

400W/1200W

- Estrutura em plástico
- Sistema oscilante
- Selector de potência
- Resistente a altas temperaturas
- Protecção contra sobreaquecimento
- Baixo consumo

- Armazón en plástico
- Sistema oscilante
- Selector de potencia
- Resistente a altas temperaturas
- Protección contra sobrecalentamiento
- Bajo consumo

- Plastic body
- Wide-angle oscillating function
- 3 Heating powers
- High temperature resistant
- Safety tip-over switch
- Energy saving



NSB-L120F



Descrição: Radiador Halogéneo

Marca: Mader Home

N. Ref. Especificação

16061 400 / 800 / 1200 W

16060 400 / 800 / 1200 W c/Controlo Remoto

Quant. Caixa:

I.V.A:

23%

Ecorree: Ecopilhas:

0.11€ 0.00€

0.12€ 0.00€

**C/ CONTROLO REMOTO  
C/ MANDO A DISTANCIA  
REMOTE CONTROL**

TCHH12BS



**Sensor de Movimento**  
 Sensor de Movimiento  
 Notion Sensor

**RH-118**

**INFRA-VERMELHOS**  
**INFRAROJOS**  
**INFRARED**

 Descrição: **Sensor de Movimento**

 Marca: **Mader Home**

N. Ref. Especificação

**68099 RH-118 - Infra-Vermelhos**

Quant. Caixa:

I.V.A:

**23%**

Ecorree: Ecopilhas:

**0.00€ 0.00€**

**Campainha Wireless**  
 Timbre sin Hilos  
 Wireless Doorbell

**TH-D28**
**100M**

**16 MELODIAS**  
**16 MELODÍAS**  
**16 MELODIES**

 Descrição: **Campainha Wireless**

 Marca: **Mader Home**

N. Ref. Especificação

**68098 100m - 16 melodias**

Quant. Caixa:

I.V.A:

**23%**

Ecorree: Ecopilhas:

**0.00€ 0.00€**

**Esticador para Cortinado**  
Tensor de Cortina  
Curtain Wire

**6 CAMARÕES**  
**6 HEMBRILLAS**  
**6 SCREW OPEN HOOKS**

**5 m**



Descrição: **Esticador para Cortinado**

Marca: **Mader Home**

N. Ref. Especificação

**68197 5 m c/ 6 Camarões**

Quant. Caixa:

I.V.A:

**23%**

Ecorree: Ecopilhas:

**0.00€ 0.00€**



**Cabide**  
**Percha**  
**Robe Hook**
**DUPLO**  
**DOBLE**  
**DOUBLE**
**INOX**

Descrição: <b>Cabide</b>	I.V.A:	
Marca: <b>Mader Home</b>	<b>23%</b>	
N. Ref. Especificação	Ecorree:	Ecopilhas:
<b>68192 Duplo - Inox</b>	<b>0.00€</b>	<b>0.00€</b>
Quant. Caixa:		

**Toalheiro**  
**Toallero**  
**Towel Holder**
**ANEL**  
**ANILLO**  
**RING**
**INOX**

Descrição: <b>Toalheiro</b>	I.V.A:	
Marca: <b>Mader Home</b>	<b>23%</b>	
N. Ref. Especificação	Ecorree:	Ecopilhas:
<b>68195 Anel - Inox</b>	<b>0.00€</b>	<b>0.00€</b>
Quant. Caixa:		

**Toalheiro**  
**Toallero**  
**Towel Holder**
**600 mm**
**INOX**

Descrição: <b>Toalheiro</b>	I.V.A:	
Marca: <b>Mader Home</b>	<b>23%</b>	
N. Ref. Especificação	Ecorree:	Ecopilhas:
<b>68191 600 mm - Inox</b>	<b>0.00€</b>	<b>0.00€</b>
Quant. Caixa:		

**Suporte - Sabonete**  
**Soporte - Jabón**  
**Soap Holder**

**INOX**

 Descrição: **Suporte - Sabonete**

 Marca: **Mader Home**

N. Ref. Especificação

**68193** **Inox**

Quant. Caixa:

I.V.A:

**23%**

Ecorree: Ecopilhas:

**0.00€**
**0.00€**

**Suporte - Papel Higiénico**  
**Soporte - Papel Higiénico**  
**Paper Holder**

**INOX**

 Descrição: **Suporte - Papel Higiénico**

 Marca: **Mader Home**

N. Ref. Especificação

**68194** **Inox**

Quant. Caixa:

I.V.A:

**23%**

Ecorree: Ecopilhas:

**0.00€**
**0.00€**

**Suporte - Piaçaba**  
**Soporte - Piasava**  
**Toilet Brush Holder**

**INOX**

 Descrição: **Suporte - Piaçaba**

 Marca: **Mader Home**

N. Ref. Especificação

**68196** **Inox**

Quant. Caixa:

I.V.A:

**23%**

Ecorree: Ecopilhas:

**0.00€**
**0.00€**

## Mata Moscas e Mosquitos Matamoscas Electric Insect Kiler

**ELÉCTRICO  
ELÉCTRICO  
ELECTRIC**

- Potência / Potencia / Power: 3W
- Área Aproximada / Área Aproximada / Approximate area: 18m<sup>3</sup>
- Tensão / Tensión / Voltage: 230V/50Hz
- Isolamento / Aislamiento / Isolation: Duplo / Doble / Double (Class II)
- Dimensões / Dimensiones / Dimensions:
- Peso / Peso / Height:



3 W



**LÂMPADA NEON  
LAMPARA NEON  
NEON LAMP**

Descrição: Mata Moscas e Mosquitos

Marca: Mader Home

N. Ref. Especificação

10032 3W

Quant. Caixa:

I.V.A:

23%

Ecorree: Ecopilhas:

0.05€ 0.00€

## Mata Moscas e Mosquitos Matamoscas Electric Insect Kiler

**ELÉCTRICO  
ELÉCTRICO  
ELECTRIC**

- Potência / Potencia / Power: 12W
- Lâmpada / Bombilla / Bulb: 2x 6W
- Área Aproximada / Área Aproximada / Approximate area: 30m<sup>3</sup>
- Tensão / Tensión / Voltage: 230V/50Hz
- Isolamento / Aislamiento / Isolation: Duplo / Doble / Double (Class II)
- Dimensões / Dimensiones / Dimensions: 270x255x105mm
- Peso / Peso / Height: 1.25Kg



12 W



- Potência / Potencia / Power: 20W
- Lâmpada / Bombilla / Bulb: 2x 10W
- Área Aproximada / Área Aproximada / Approximate area: 40m<sup>3</sup>
- Tensão / Tensión / Voltage: 230V/50Hz
- Isolamento / Aislamiento / Isolation: Duplo / Doble / Double (Class II)
- Dimensões / Dimensiones / Dimensions: 395x295x105mm
- Peso / Peso / Height: 1.6Kg



20 W



Descrição: Mata Moscas e Mosquitos

Marca: Mader Home

N. Ref. Especificação

10034 12W

10033 20W

Quant. Caixa:

I.V.A:

23%

Ecorree: Ecopilhas:

0.15€ 0.00€

0.16€ 0.00€

**LÂMPADA NEON  
LAMPARA NEON  
NEON LAMP**

## Mata Moscas e Mosquitos

### Matamoscas

### Electric Insect Kiler

**ELÉCTRICO**  
**ELÉCTRICO**  
**ELECTRIC**

- Potência / Potencia / Power: 40W
- Lâmpada / Bombilla / Bulb: 2x 20W
- Área Aproximada / Área Aproximada / Approximate area: 120m<sup>3</sup>
- Tensão / Tensión / Voltage: 230V/50Hz
- Isolamento / Aislamiento / Isolation: Duplo / Doble / Double (Class II)
- Dimensões / Dimensiones / Dimensions: 650x385x105mm
- Peso / Peso / Height: 2.6Kg

40 W



**LÂMPADA NEON**  
**LAMPARA NEON**  
**NEON LAMP**

Descrição: Mata Moscas e Mosquitos

Marca: Mader Home

N. Ref. Especificação

10035 40W

Quant. Caixa:

I.V.A:

23%

Ecorree: Ecopilhas:

0.28€

0.00€

## Lâmpada Neon » Mata Moscas e Mosquitos

### Bombilla Neon » Matamoscas

### Neon Bulb » Electric Insect Kiler



3W



6W



10W



20W



Descrição: Lâmpada para Mata Moscas

Marca: Mader Home

N. Ref. Especificação

10036 3W - Neon

10037 6W - Neon

10038 10W - Neon

10039 20W - Neon

Quant. Caixa:

I.V.A:

23%

Ecorree: Ecopilhas:

0.00€

0.00€



## Cuba Inox

### Cuba Inox

### Stainless Steel Tank

**SEM TORNEIRA**  
**SIN PUNTEE**  
**WITHOUT TAP**



10L



15L



20L



Descrição: **Cuba Inox**

Marca: **Mader Home**

N. Ref. Especificação

29318 c/Pegas - 10L

29320 c/Pegas - 15L

29319 c/Pegas - 20L

Quant. Caixa:

I.V.A:

23%

Ecorree: Ecopilhas:

0.00€ 0.00€

## Torneira

### Puntee

### Faucet



3/4"



Descrição: **Torneira**

Marca: **Mader Home**

N. Ref. Especificação

29326 p/Cuba Inox - 3/4"

Quant. Caixa:

I.V.A:

23%

Ecorree: Ecopilhas:

0.00€ 0.00€



**Caixas Multiusos**  
**Cajas Multiusos**  
**Multiuse Boxes**



**5L**



**14L**



**20L**



**26L**



**30L**



**40L**



**70L**



Descrição: **Caixas Multiusos**

Marca: **Mader Home**

N. Ref.	Especificação	Quant. Caixa:
06010	2005005 - 5L	
06011	2005015 - 14L	
06012	2005020 - 20L	
06013	2005026 - 26L	
06014	2005030 - 30L	
06015	2005040 - 40L	
06017	2005070 - 70L	

I.V.A:  
**23%**  
 Ecorree: Ecopilhas:  
**0.00€ 0.00€**

## Balde Lixo

### Cubo Basura

### Waste Bin

**35L - Amarelo**

**35L - Azul**

**35L - Verde**

 Descrição: **Balde Lixo**

 Marca: **LEI**

N. Ref.	Especificação	Quant. Caixa:
06030	400435 - Amarelo - 35L	
06031	400435 - Azul - 35L	
06032	400435 - Verde - 35L	

I.V.A:	23%
Ecorree:	0.00€
Ecopilhas:	0.00€

## Balde Lixo

### Cubo Basura

### Waste Bin

**45 L - Azul**

**45 L - Verde**

**45 L - Amarelo**

**45 L - Preto**

 Descrição: **Balde Lixo**

 Marca: **Mader**

N. Ref.	Especificação	Quant. Caixa:
99986	c/ Tampa - Azul - 45L	
99987	c/ Tampa - Verde - 45L	
99989	c/ Tampa - Amarelo - 45L	
99990	c/ Tampa - Preto - 45L	

I.V.A:	23%
Ecorree:	0.00€
Ecopilhas:	0.00€

**Vassoura Doméstica**  
**Escoba Doméstica**  
**House Broom**

**120CM / 240MM**

**LARGA**  
**ANCHA**  
**WIDE**

Unidade



56022251681450



Descrição: **Vassoura Doméstica**

Marca: **Mader Home**

N. Ref. Especificação Quant. Caixa:  
**68145 24 x 120cm - Larga (várias cores)**

I.V.A:

**23%**

Ecorree: Ecopilhas:

**0.00€ 0.00€**

**Vassoura Doméstica**  
**Escoba Doméstica**  
**House Broom**

**92CM / 250MM**

**LARGA**  
**ANCHA**  
**WIDE**



56022251681467



Descrição: **Vassoura Doméstica**

Marca: **Mader Home**

N. Ref. Especificação Quant. Caixa:  
**68146 25 x 92 cm - Larga (Azul)**

I.V.A:

**23%**

Ecorree: Ecopilhas:

**0.00€ 0.00€**

**Balde**  
**Cubo**  
**Pail**



50L



Descrição: <b>Selha</b>		I.V.A:	
Marca: <b>LEI</b>		<b>23%</b>	
N. Ref.	Especificação	Quant. Caixa:	Ecorree: Ecopilhas:
<b>06073</b>	<b>20210 - Plástico - 50L</b>		<b>0.00€ 0.00€</b>

**Caixa**  
**Caja**  
**Box**



16"



13"



19"



Descrição: <b>Mala Ferramenta</b>		I.V.A:	
Marca: <b>LEI</b>		<b>23%</b>	
N. Ref.	Especificação	Quant. Caixa:	Ecorree: Ecopilhas:
<b>06045</b>	<b>400300 - 1300 - 13"</b>		<b>0.00€ 0.00€</b>
<b>06046</b>	<b>400400 - 1400 - 16"</b>		
<b>06047</b>	<b>400500 - 1500 - 19"</b>		
<b>06048</b>	<b>400600 - 1600 - 26"</b>		

26"



**Mala Térmica**  
**Bolsa Térmica**  
**Thermal Bag**



7 L



10 L



Descrição: <b>Mala Térmica</b>		I.V.A:	
Marca: <b>LEI</b>		<b>23%</b>	
N. Ref.	Especificação	Quant. Caixa:	Ecorree: Ecopilhas:
<b>06036</b>	<b>200203 - 7 L</b>		<b>0.00€ 0.00€</b>
<b>06037</b>	<b>200206 - 10 L</b>		
<b>06040</b>	<b>200230 - 30 L</b>		

30 L



## Expositor Plástico

### Plastic Exhibitor



Descrição: **Expositor Plástico**

Marca: **LEI**

N. Ref. Especificação  
**06070 68002**

Quant. Caixa:

I.V.A:

**23%**

Ecorree: Ecopilhas:  
**0.00€ 0.00€**

## Garrafeira Plástica

### Bodega Pequeña

### Wine Cellar



Descrição: **Garrafeira Plástica**

Marca: **LEI**

N. Ref. Especificação  
**06072 68003**

Quant. Caixa:

I.V.A:

**23%**

Ecorree: Ecopilhas:  
**0.00€ 0.00€**

## Desentupidor Borracha

### Desatascador Goma

### Force Cup



Descrição: **Desentupidor Borracha**

Marca: **Mader House**

N. Ref. Especificação  
**10050 Cabo Plástico**

Quant. Caixa:

I.V.A:

**23%**

Ecorree: Ecopilhas:  
**0.00€ 0.00€**

## Estrado para Chão Estrado para Suelo



50 x 50 x 2.4 cm

50 x 50 x 4.8 cm

50 x 50 x 2.4 cm



50 x 50 x 4.8 cm



Descrição: Estrado para Chão

Marca: LEI

N. Ref. Especificação  
99980 50 x 50 x 2.4 cm  
99981 50 x 50 x 4.8 cm

Quant. Caixa:

I.V.A:

23%

Ecorree: Ecopilhas:  
0.00€ 0.00€

## Tapete Plástico Alfombra



Descrição: Tapete Plástico

Marca: LEI

N. Ref. Especificação  
06071 600401

Quant. Caixa:

I.V.A:

23%

Ecorree: Ecopilhas:  
0.00€ 0.00€

## Ratoeiras Plásticas Ratoeiras Plásticas Plastic Rat Trap

3un.



Descrição: Ratoeiras Plásticas

Marca: Mader House

N. Ref. Especificação  
88191 90x45mm - 3un.

Quant. Caixa:

I.V.A:

23%

Ecorree: Ecopilhas:  
0.00€ 0.00€

**Banco com Degrau**  
**Banco con el Paso**  
**Bench with Step**



Descrição: <b>Banco Plástico</b>		I.V.A:	
Marca: <b>LEI</b>		<b>23%</b>	
N. Ref.	Especificação	Quant. Caixa:	Ecorree: Ecopilhas:
<b>06075</b>	<b>600402 - com Degrau</b>		<b>0.00€ 0.00€</b>

**Floreira**  
**Ojal**  
**Flowerpot**



Descrição: <b>Floreira Plástica</b>		I.V.A:	
Marca: <b>LEI</b>		<b>23%</b>	
N. Ref.	Especificação	Quant. Caixa:	Ecorree: Ecopilhas:
<b>06050</b>	<b>67050 - Rect. Peq. - Cast / Verde</b>		<b>0.00€ 0.00€</b>
<b>06051</b>	<b>67051 - Rect. Méd. - Cast / Verde</b>		

**Floreira**  
**Ojal**  
**Flowerpot**



Descrição: <b>Floreira Plástica » Cast/Verd</b>		I.V.A:	
Marca: <b>LEI</b>		<b>23%</b>	
N. Ref.	Especificação	Quant. Caixa:	Ecorree: Ecopilhas:
<b>06053</b>	<b>66004 - Redonda - 250</b>		<b>0.00€ 0.00€</b>
<b>06054</b>	<b>66006 - Redonda - 306</b>		
<b>06055</b>	<b>66008 - Redonda - 390</b>		
<b>06060</b>	<b>361000 - Prato - 25</b>		
<b>06061</b>	<b>361402 - Prato - 35</b>		
<b>06062</b>	<b>361502 - Prato - 50</b>		



## Estendal Extensível

### Tendedero Extensible

### Extendable Drying Area

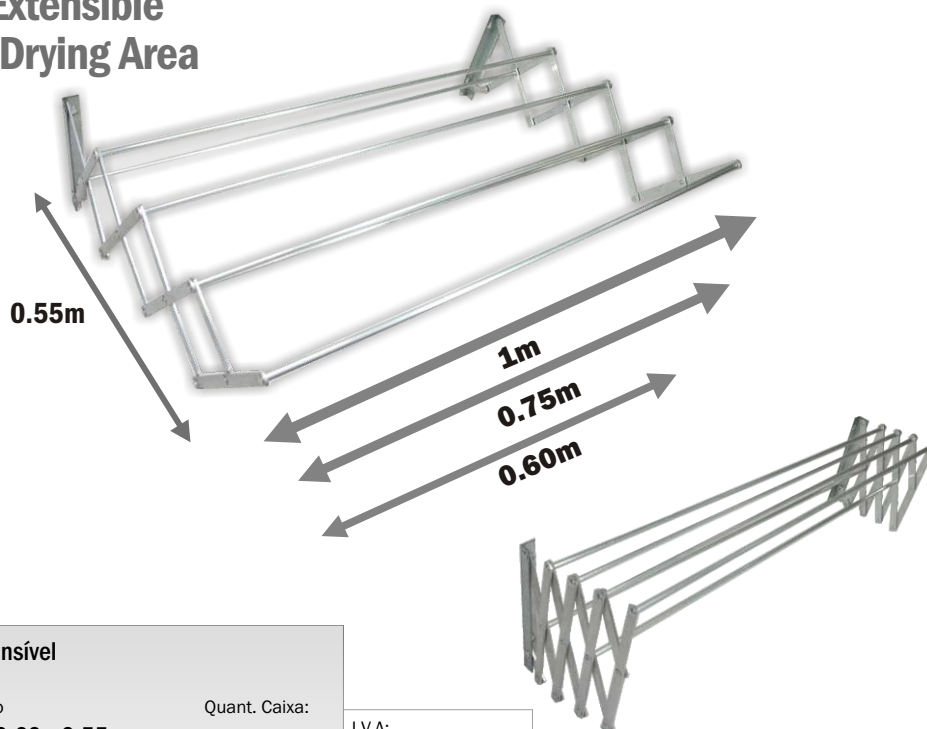

0.60x0.55m



0.75x0.55m



1x0.55m



Descrição: **Estendal Extensível**

Marca: **Mader Home**

N. Ref. Especificação

96000 Alumínio - 0.60 x 0.55 m

96001 Alumínio - 0.75 x 0.55 m

96002 Alumínio - 1.00 x 0.55 m

Quant. Caixa:

I.V.A:

23%

Ecorree: Ecopilhas:

0.00€ 0.00€

## Estendal de Tecto

### Tendedero de Suspensão

### Ceiling Drying Area

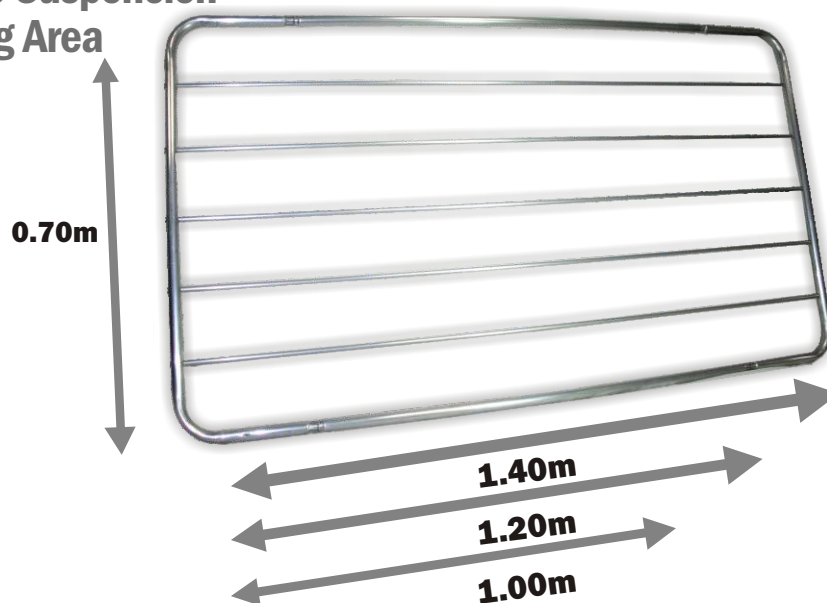

1x0.70m



1.20x0.70m



1.40x0.70m



Descrição: **Estendal de Tecto**

Marca: **Mader Home**

N. Ref. Especificação

96003 Alumínio - 1x0.70m

96004 Alumínio - 1.20x0.70m

96005 Alumínio - 1.40x0.70m

Quant. Caixa:

I.V.A:

23%

Ecorree: Ecopilhas:

0.00€ 0.00€

## Kit Primeiros Socorros Kit Primeros Auxilios First Aid Kit



Descrição: **Kit de Primeiros Socorros**

Marca: **Mader Protec**

N. Ref. Especificação  
**52517 13 pç**

I.V.A:

**23%**

Ecorree: Ecopilhas:  
**0.00€ 0.00€**

## Kit Primeiros Socorros Kit Primeros Auxilios First Aid Kit



Descrição: **Kit de Primeiros Socorros**

Marca: **Mader Protec**

N. Ref. Especificação  
**52516 16 pç**

I.V.A:

**23%**

Ecorree: Ecopilhas:  
**0.00€ 0.00€**

## Kit Primeiros Socorros Kit Primeros Auxilios First Aid Kit



Descrição: **Kit de Primeiros Socorros**

Marca: **Mader Protec**

N. Ref. Especificação  
**52518 18 pç**

I.V.A:

**23%**

Ecorree: Ecopilhas:  
**0.00€ 0.00€**





MADEIRA & MADEIRA, SA  
Importação de Ferragens e Ferramentas, SA



Telf. +351 231 200200 - Fax. +351 231 200201  
Telm. +351 919854879  
m-m@madeira-madeira.pt \* www.madeira-madeira.pt



Zona Industrial da Pedrulha, lote 13  
3050-183 Casal Comba | Mealhada, Portugal  
Apartado 100, 3050-901 Mealhada



**ONE STEP BEYOND THE FUTURE**